

## 1/4 SIZE DETAILS



THIS SYSTEM IS DESIGNED TO BE ASSEMBLED WITH #12 SCREWS.

GASKET INFORMATION

|                      |           |                              |
|----------------------|-----------|------------------------------|
| REED RUBBER COMPANY  | #3678     | INTERIOR & EXTERIOR (LIGHT)  |
| 800-325-9698         | #3679     | INTERIOR & EXTERIOR (NORMAL) |
|                      | #3680     | INTERIOR & EXTERIOR (HEAVY)  |
| UNIVERSAL RUBBER CO. | #3194     | INTERIOR & EXTERIOR          |
| 800-782-2375         |           |                              |
| TREMCO               | #TR-2860E | INTERIOR & EXTERIOR (NORMAL) |
| 800-321-6357         |           |                              |

DOOR PILE







|                     |             |                                    |
|---------------------|-------------|------------------------------------|
| SCHLEGEL CORP.      | AS SELECTED | USED WITH BCE-9314 AND LIKE SHAPES |
| 800-828-6237        |             |                                    |
| AMESBURY GROUP INC. | AS SELECTED | USED WITH BCE-9314 AND LIKE SHAPES |
| 704-878-6892        |             |                                    |

NO TEST DATA AVAILABLE  
 TREDEGAR EXTRUSIONS INC. DOES NOT MAKE ANY WARRANTY EXPRESS OR IMPLIED INCLUDING  
 NO WARRANTY OF MERCHANTABILITY OR FITNESS FOR A PARTICULAR PURPOSE AND RESERVES  
 THE RIGHT TO MAKE CHANGES  
 REPRODUCTION RIGHTS RESERVED

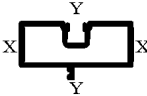
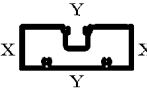
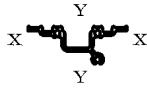
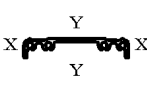
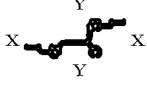
**PRICING FACTORS**  
**1 3/4" x 4 1/2" FLUSH GLAZED**  
**BCE-9200 SERIES**

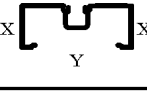
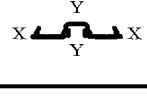
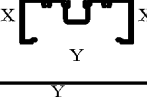

| WEIGHT PER FT | EST PER | FACTOR | CAVITY AREA | PART NUMBER | STRUCTURAL VALUES |   |       | 1/8 SIZE DETAILS |
|---------------|---------|--------|-------------|-------------|-------------------|---|-------|------------------|
|               |         |        |             |             | X-X               | I | Y-Y   |                  |
| 0.474         | 12.592  | 27     | N/A         | BCE114      | 0.006             | I | 1.116 |                  |
|               |         |        |             |             | 0.010             | S | 0.374 |                  |
| 1.267         | 21.440  | 17     | N/A         | BCE461      | 2.454             | I | 2.503 |                  |
|               |         |        |             |             | 0.770             | S | 0.791 |                  |
| 1.267         | 13.834  | 17     | N/A         | BCE1867     | 2.454             | I | 2.503 |                  |
|               |         |        |             |             | 0.770             | S | 0.791 |                  |
| 0.328         | 8.836   | 27     | N/A         | BCE1876     | 0.002             | I | 0.366 |                  |
|               |         |        |             |             | 0.006             | S | 0.204 |                  |
| 1.567         | 17.169  | 20     | N/A         | BCE9200     | 0.569             | I | 2.656 |                  |
|               |         |        |             |             | 0.641             | S | 1.180 |                  |
| 1.043         | 20.126  | 19     | N/A         | BCE9201     | 0.273             | I | 2.043 |                  |
|               |         |        |             |             | 0.293             | S | 0.824 |                  |
| 1.494         | 15.304  | 19     | N/A         | BCE9202     | 0.429             | I | 2.303 |                  |
|               |         |        |             |             | 0.413             | S | 0.958 |                  |
| 0.284         | 8.976   | 32     | N/A         | BCE9204     | 0.027             | I | 0.114 |                  |
|               |         |        |             |             | 0.039             | S | 0.116 |                  |
| 1.768         | 13.415  | 15     | N/A         | BCE9205     | 0.828             | I | 3.273 |                  |
|               |         |        |             |             | 0.867             | S | 1.464 |                  |
| 1.499         | 15.196  | 19     | N/A         | BCE9206     | 0.585             | I | 2.853 |                  |
|               |         |        |             |             | 0.663             | S | 1.268 |                  |
| 0.878         | 18.771  | 21     | N/A         | BCE9207     | 0.149             | I | 1.909 |                  |
|               |         |        |             |             | 0.132             | S | 0.848 |                  |
| 0.938         | 19.564  | 21     | N/A         | BCE9208     | 0.072             | I | 1.805 |                  |
|               |         |        |             |             | 0.108             | S | 0.802 |                  |
| 1.712         | 14.570  | 15     | N/A         | BCE9209     | 0.861             | I | 3.122 |                  |
|               |         |        |             |             | 0.640             | S | 1.382 |                  |
| 1.441         | 15.304  | 19     | N/A         | BCE9212     | 0.423             | I | 2.245 |                  |
|               |         |        |             |             | 0.405             | S | 0.925 |                  |

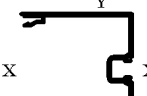
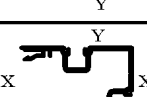
| WEIGHT<br>PER FT | EST PER | FACTOR | CAVITY<br>AREA | PART<br>NUMBER | STRUCTURAL<br>VALUES |   |       | 1/8 SIZE DETAILS  |
|------------------|---------|--------|----------------|----------------|----------------------|---|-------|---|
|                  |         |        |                |                | X-X                  | I | Y-Y   |   |
| 1.577            | 16.702  | 19     | N/A            | BCE9251        | 0.667                | I | 2.856 |    |
|                  |         |        |                |                | 0.503                | S | 1.264 |   |
| 1.601            | 15.181  | 19     | N/A            | BCE9252        | 0.627                | I | 2.837 |    |
|                  |         |        |                |                | 0.673                | S | 1.261 |   |
| 1.181            | 15.419  | 13     | N/A            | BCE9300        | 0.177                | I | 1.006 |    |
|                  |         |        |                |                | 0.175                | S | 0.476 |   |
| 1.104            | 14.085  | 13     | N/A            | BCE9301        | 0.027                | I | 1.849 |    |
|                  |         |        |                |                | 0.048                | S | 0.875 |   |
| 1.084            | 14.579  | 13     | N/A            | BCE9302        | 0.195                | I | 0.906 |    |
|                  |         |        |                |                | 0.241                | S | 0.415 |   |
| 0.174            | 5.679   | 33     | N/A            | BCE9314        | 0.007                | I | 0.024 |    |
|                  |         |        |                |                | 0.015                | S | 0.035 |   |
| 0.079            | 2.581   | 33     | N/A            | BCE9315        | 0.000                | I | 0.007 |   |
|                  |         |        |                |                | 0.000                | S | 0.013 |   |
| 0.340            | 9.642   | 28     | N/A            | BCE9316        | 0.026                | I | 0.079 |  |
|                  |         |        |                |                | 0.051                | S | 0.097 |   |
| 1.093            | 22.260  | 20     | N/A            | BCE9330        | 0.315                | I | 2.527 |  |
|                  |         |        |                |                | 0.284                | S | 1.123 |   |
| 0.434            | 11.593  | 27     | N/A            | BCE9332        | 0.013                | I | 0.383 |  |
|                  |         |        |                |                | 0.034                | S | 0.213 |   |
| 1.190            | 23.789  | 20     | N/A            | BCE9333        | 0.333                | I | 2.655 |  |
|                  |         |        |                |                | 0.291                | S | 1.180 |   |
| 1.495            | 25.838  | 17     | N/A            | BCE9345        | 2.468                | I | 2.661 |  |
|                  |         |        |                |                | 0.759                | S | 0.879 |   |
| 1.477            | 25.334  | 17     | N/A            | BCE9346        | 2.638                | I | 2.437 |  |
|                  |         |        |                |                | 0.873                | S | 0.746 |   |
| 1.726            | 30.046  | 17     | N/A            | BCE9349        | 2.692                | I | 2.705 |  |
|                  |         |        |                |                | 0.865                | S | 0.870 |   |

PRICING FACTORS  
1 3/4" x 4 1/2" FLUSH GLAZED  
BCE-9200 SERIES



**BONNELL**  
ALUMINUM

| WEIGHT<br>PER FT | EST PER | FACTOR | CAVITY<br>AREA | PART<br>NUMBER | STRUCTURAL<br>VALUES |   |       | 1/8 SIZE DETAILS |
|------------------|---------|--------|----------------|----------------|----------------------|---|-------|------------------|
|                  |         |        |                |                | X-X                  | I | Y-Y   |                  |
| 0.181            | 5.808   | 32     | N/A            | BCE9370        | 0.005                | I | 0.019 |                  |
|                  |         |        |                |                | 0.013                | S | 0.030 |                  |
| 1.368            | 12.473  | 18     | N/A            | A9342          | 0.640                | I | 2.853 |                  |
|                  |         |        |                |                | 0.731                | S | 1.268 |                  |
| 1.967            | 17.973  | 18     | N/A            | A7047          | 5.308                | I | 5.308 |                  |
|                  |         |        |                |                | 2.359                | S | 2.359 |                  |
| 2.626            | 17.973  | 13     | N/A            | A7043          | 6.984                | I | 6.984 |                  |
|                  |         |        |                |                | 3.104                | S | 3.104 |                  |

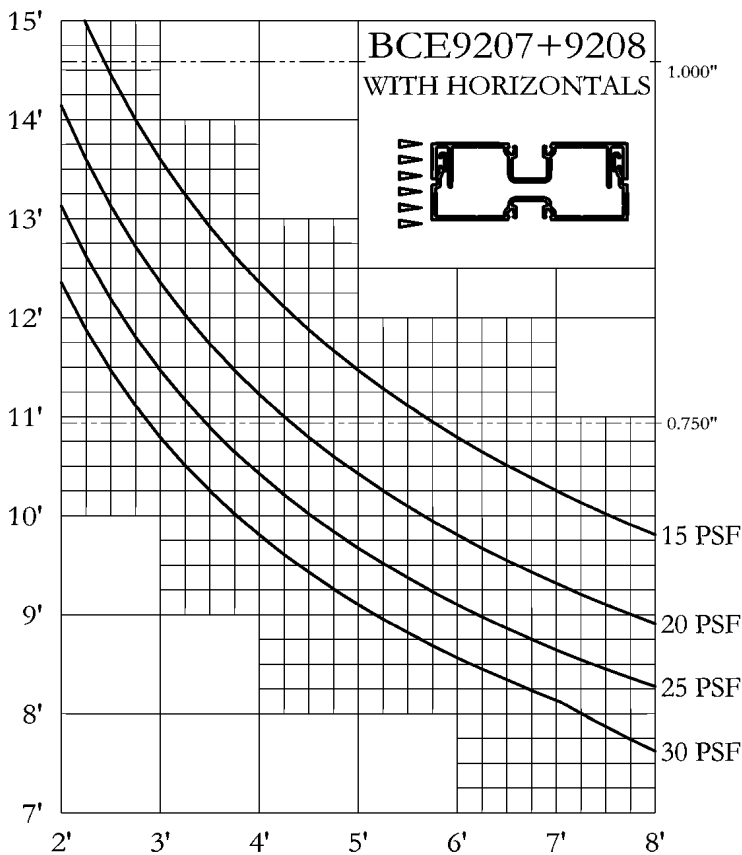
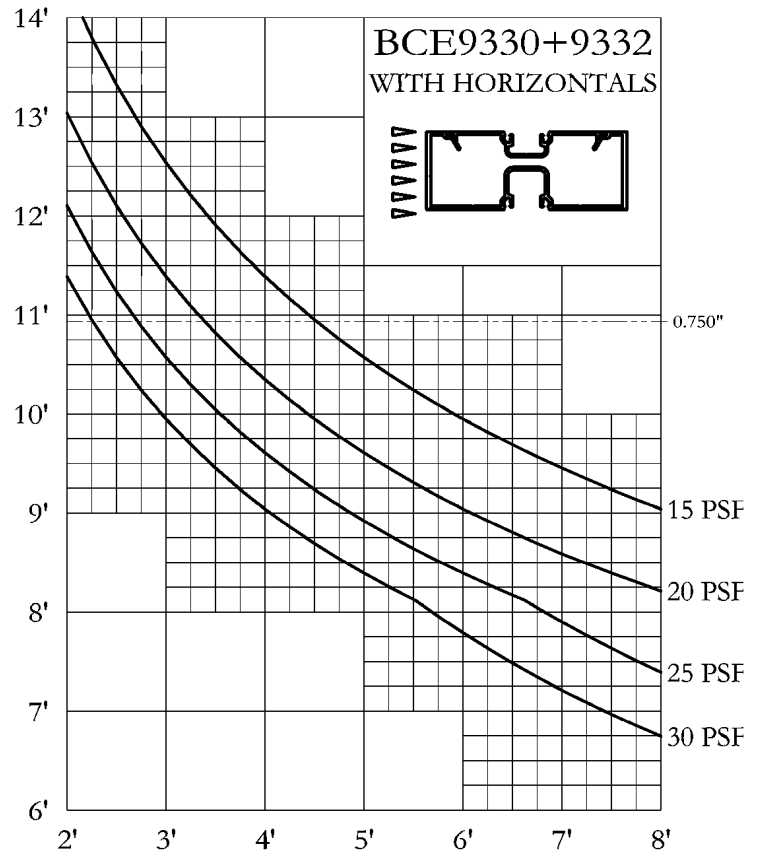
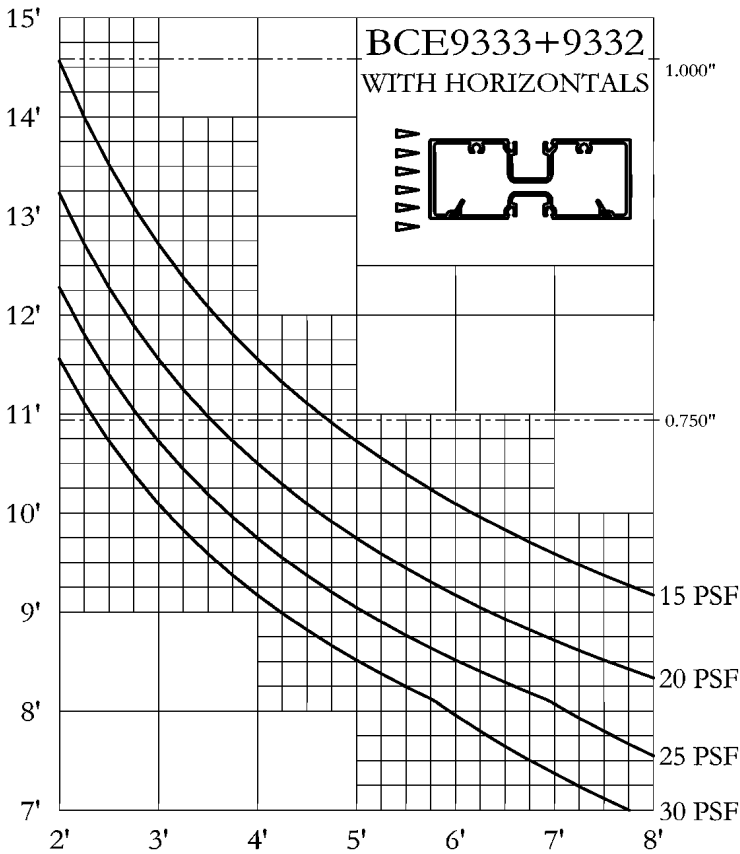

#1 THESE WINDLOAD CHARTS ARE BASED UPON THE LESSER OF DEFLECTION RATIO (L/175) OR STRESS (12667)

#2 THESE STRUCTURAL CURVES ARE ESTIMATES AND ARE PRESENTED TO THE BEST KNOWLEDGE OF THE WILLIAM L BONNELL CO. IT IS, HOWEVER, THE RESPONSIBILITY OF THE CUSTOMER TO BE SATISFIED THAT THE CURVES ARE CORRECT. THE WILLIAM L BONNELL CO. MAY NOT BE HELD RESPONSIBLE IN ANY WAY FOR THE FAILURE OF PERFORMANCE RESULTING FROM THE USE OF THESE CURVES.

WINDLOAD CHARTS  
1 3/4" x 4 1/2" FLUSH GLAZED  
BCE-9200 SERIES

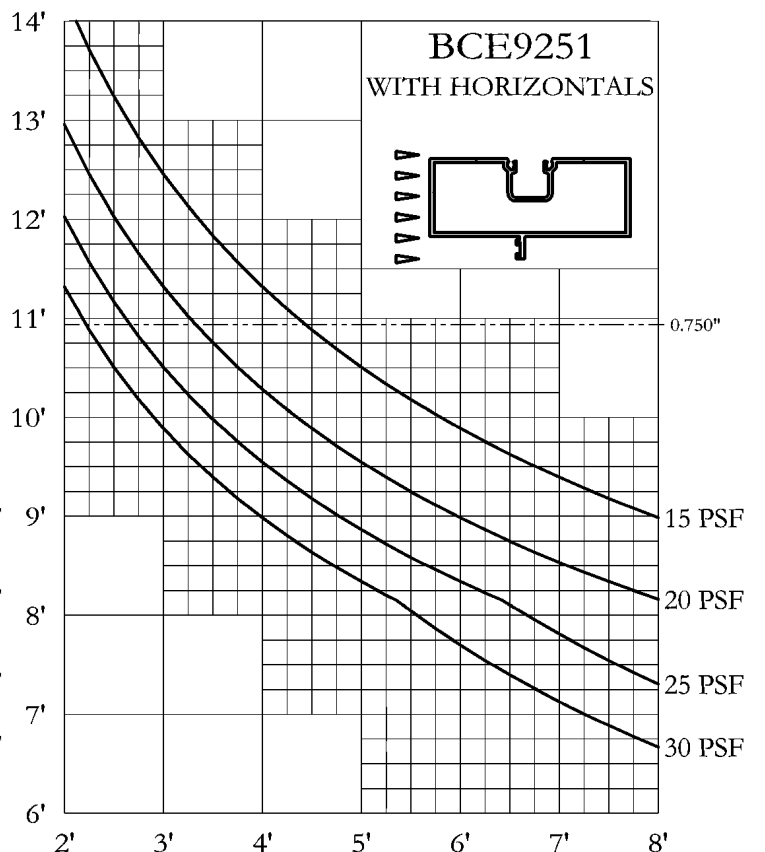
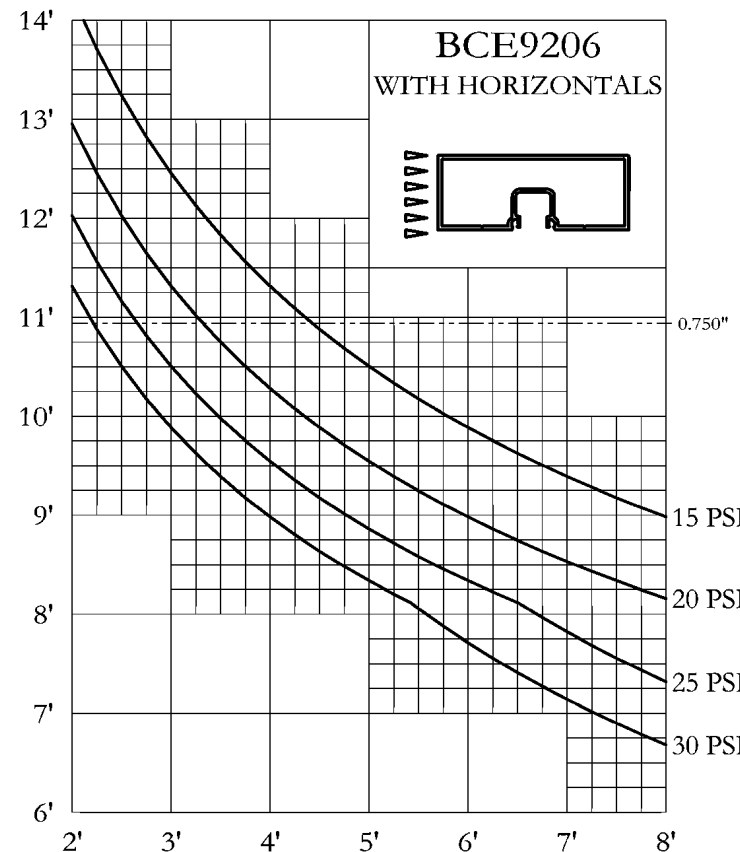
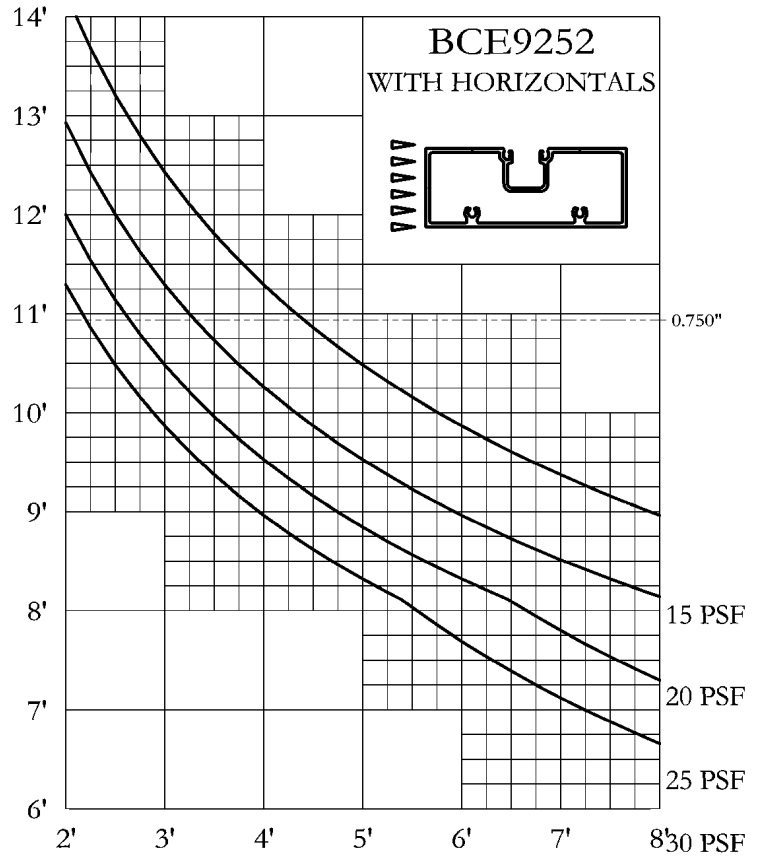
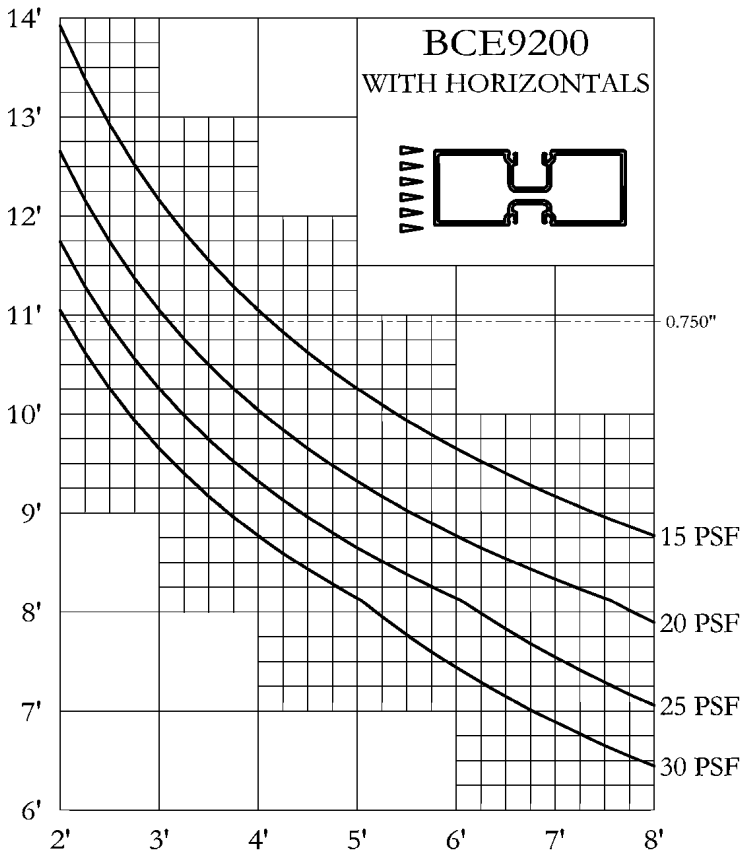

#1 THESE WINDLOAD CHARTS ARE BASED UPON THE LESSER OF DEFLECTION RATIO (L/175) OR STRESS (12667)

#2 THESE STRUCTURAL CURVES ARE ESTIMATES AND ARE PRESENTED TO THE BEST KNOWLEDGE OF THE WILLIAM L BONNELL CO. IT IS, HOWEVER, THE RESPONSIBILITY OF THE CUSTOMER TO BE SATISFIED THAT THE CURVES ARE CORRECT. THE WILLIAM L BONNELL CO. MAY NOT BE HELD RESPONSIBLE IN ANY WAY FOR THE FAILURE OF PERFORMANCE RESULTING FROM THE USE OF THESE CURVES.



FULL SIZE DETAILS

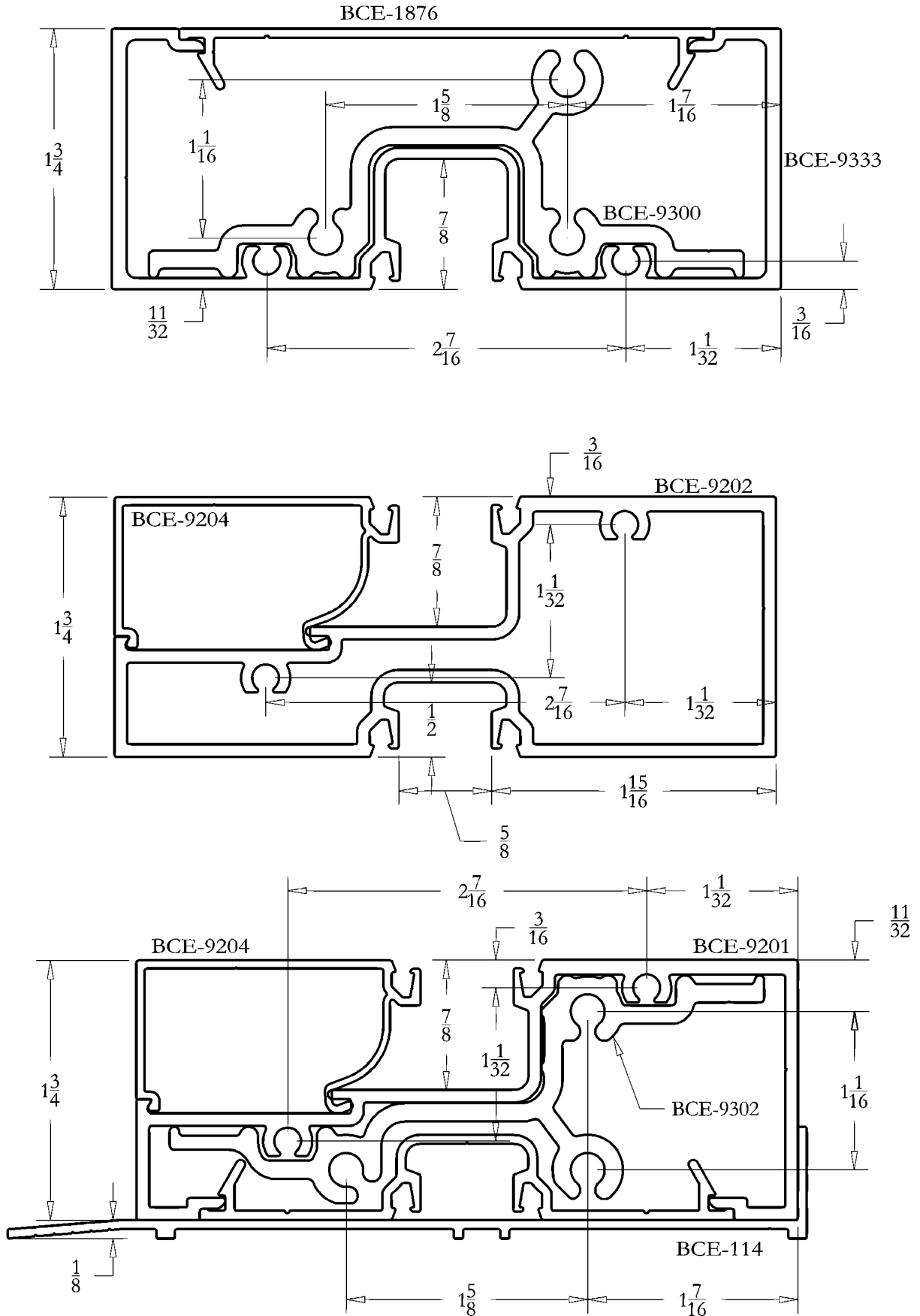

DETAIL SHEET  
1 3/4" x 4 1/2" FLUSH GLAZED  
BCE-9200 SERIES

FULL SIZE DETAILS

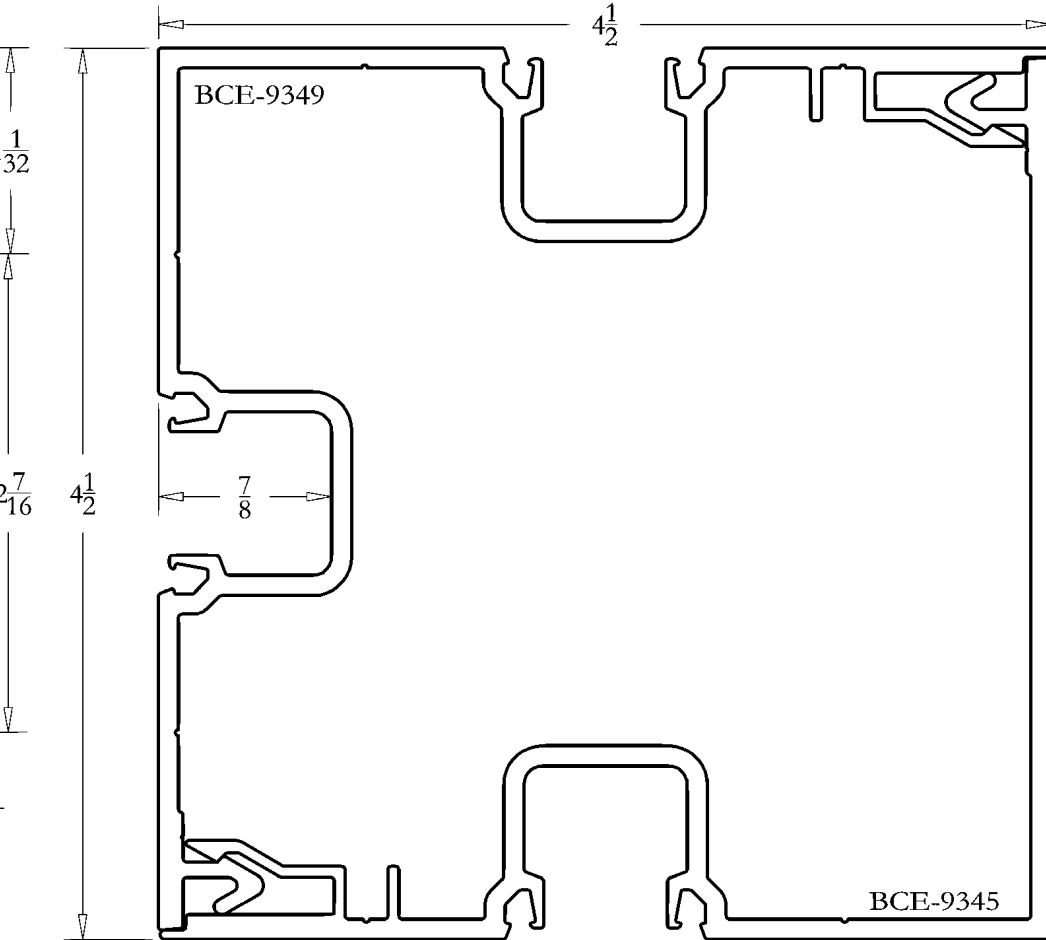
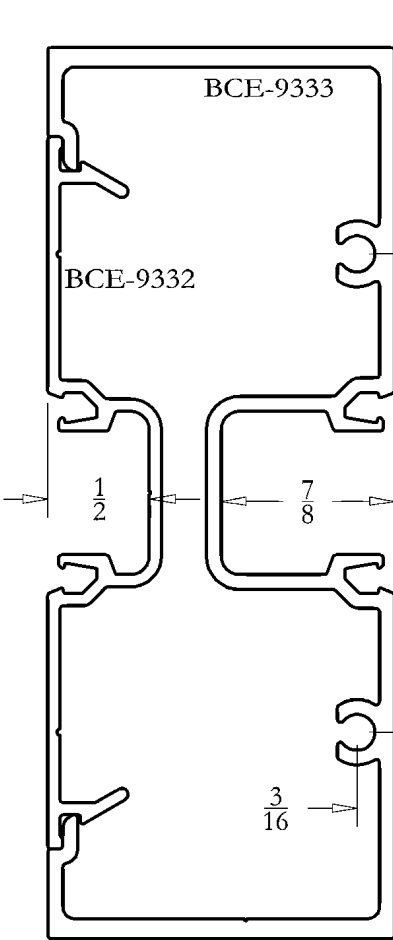
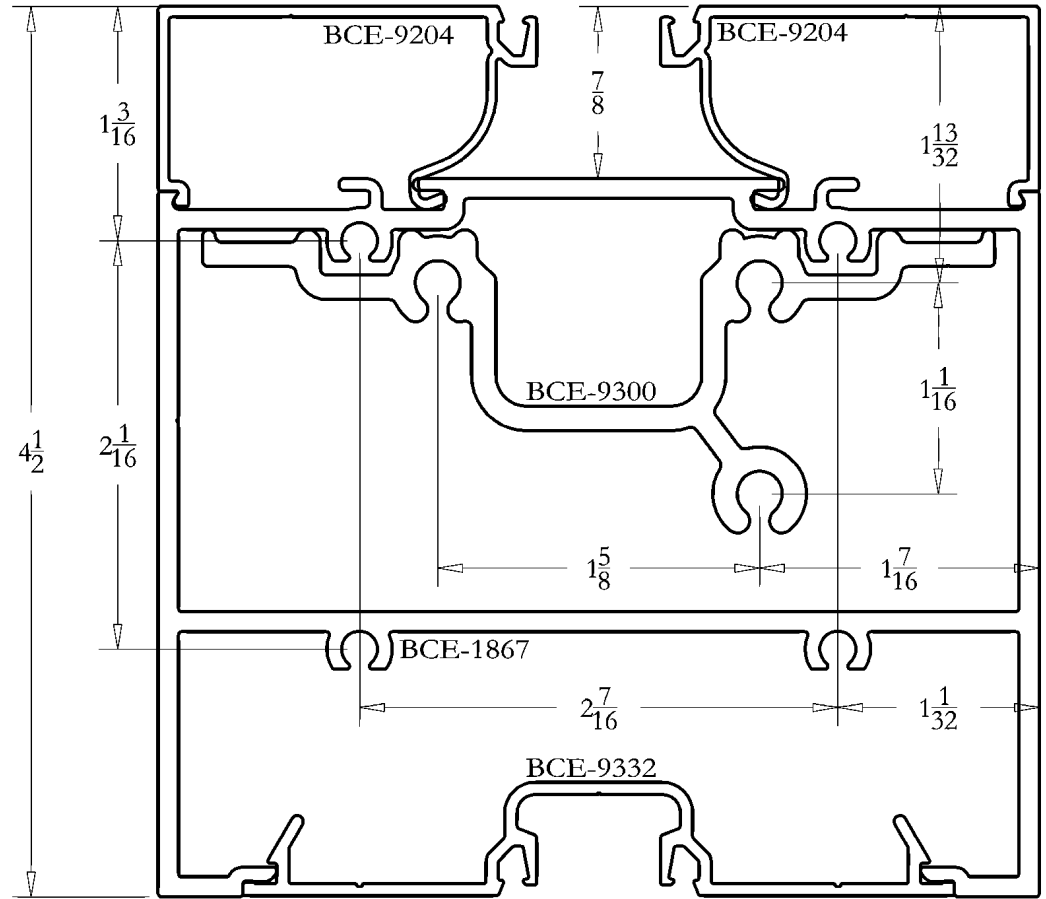
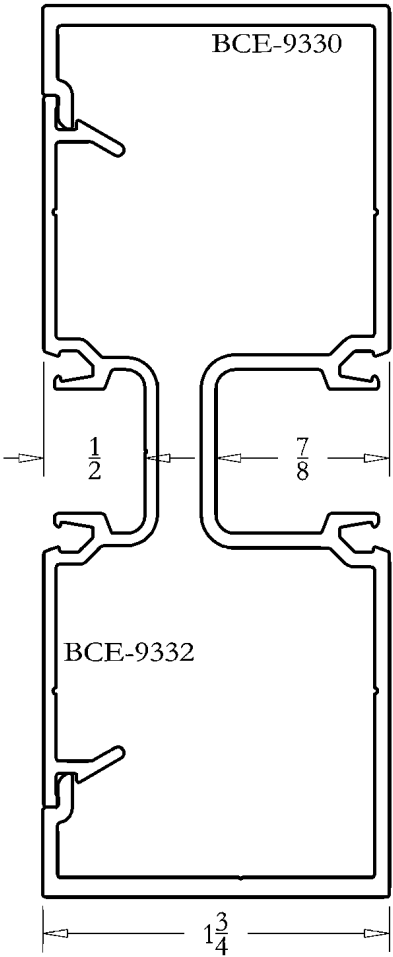





FULL SIZE DETAILS

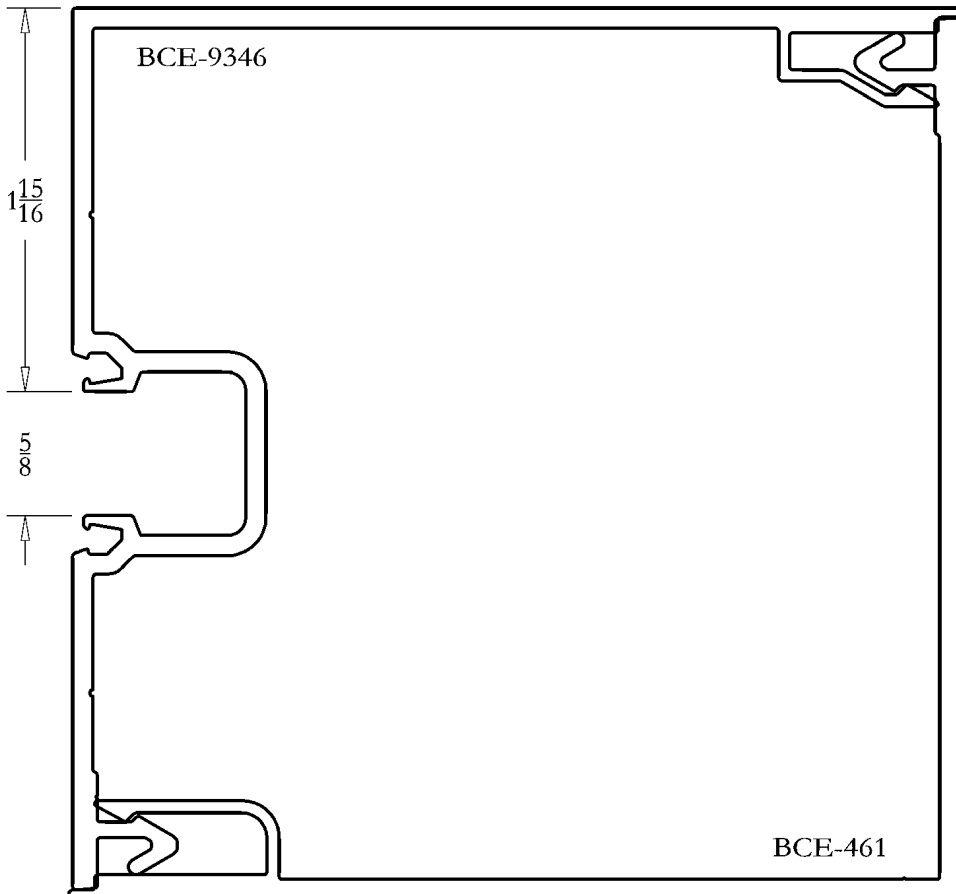
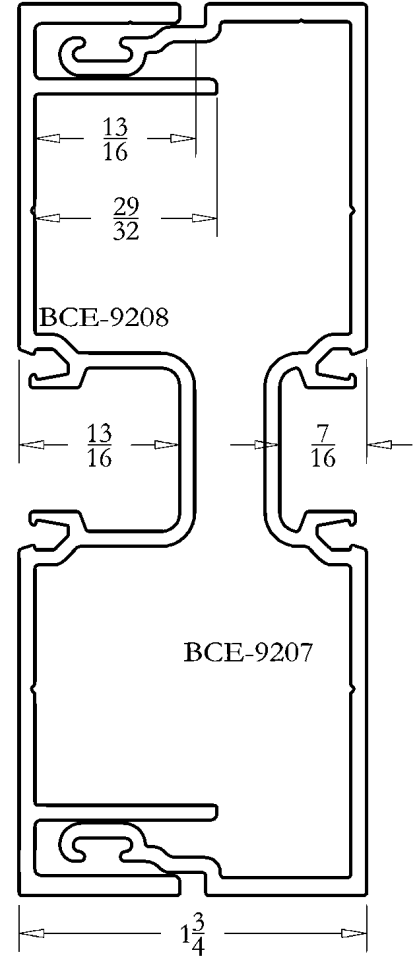
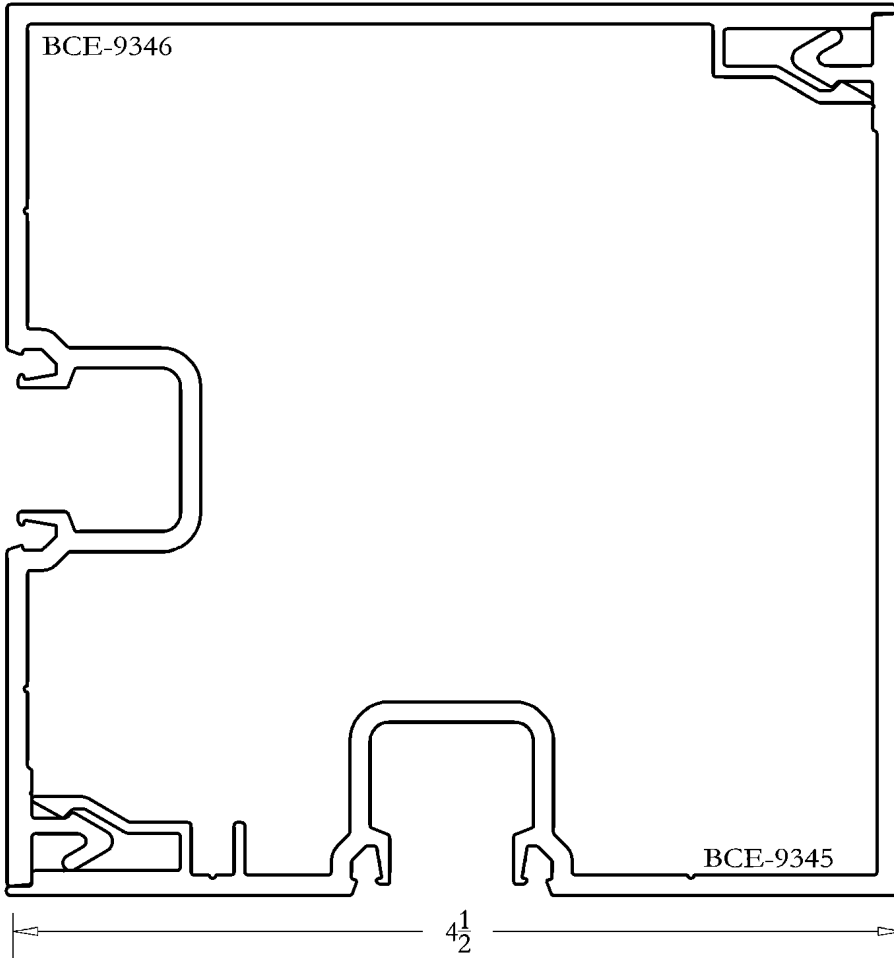

DETAIL SHEET  
1 3/4" x 4 1/2" FLUSH GLAZED  
BCE-9200 SERIES

FULL SIZE DETAILS

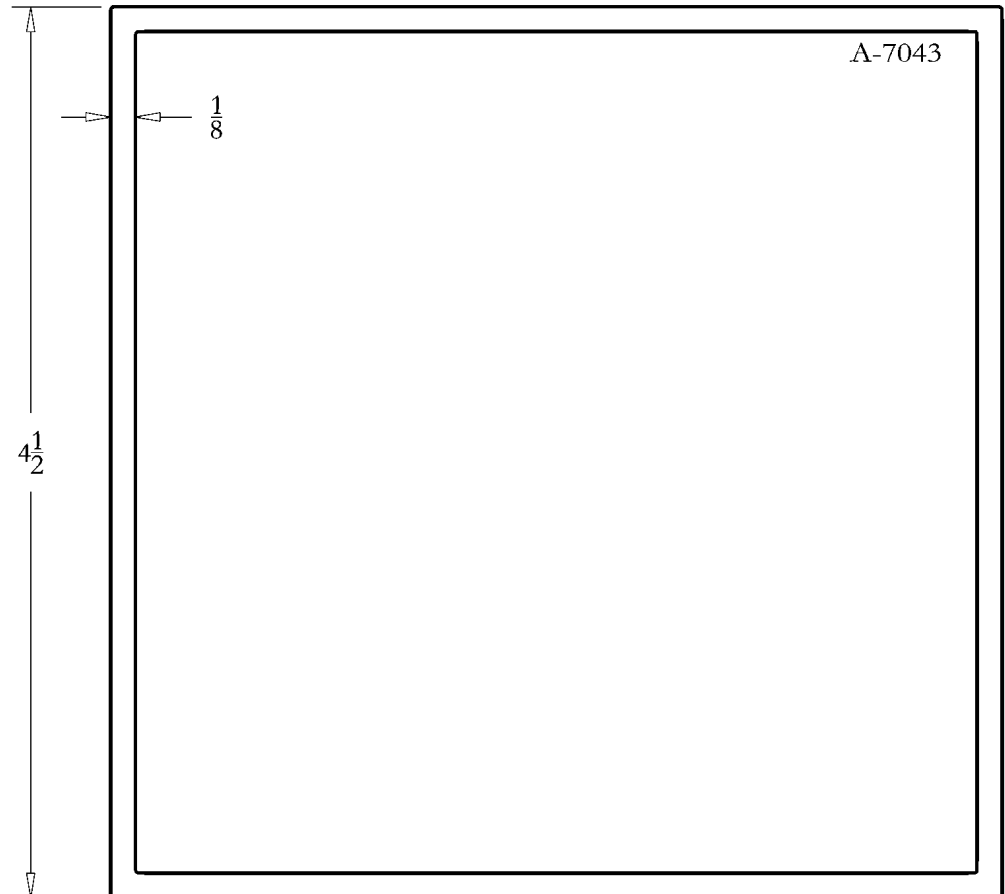
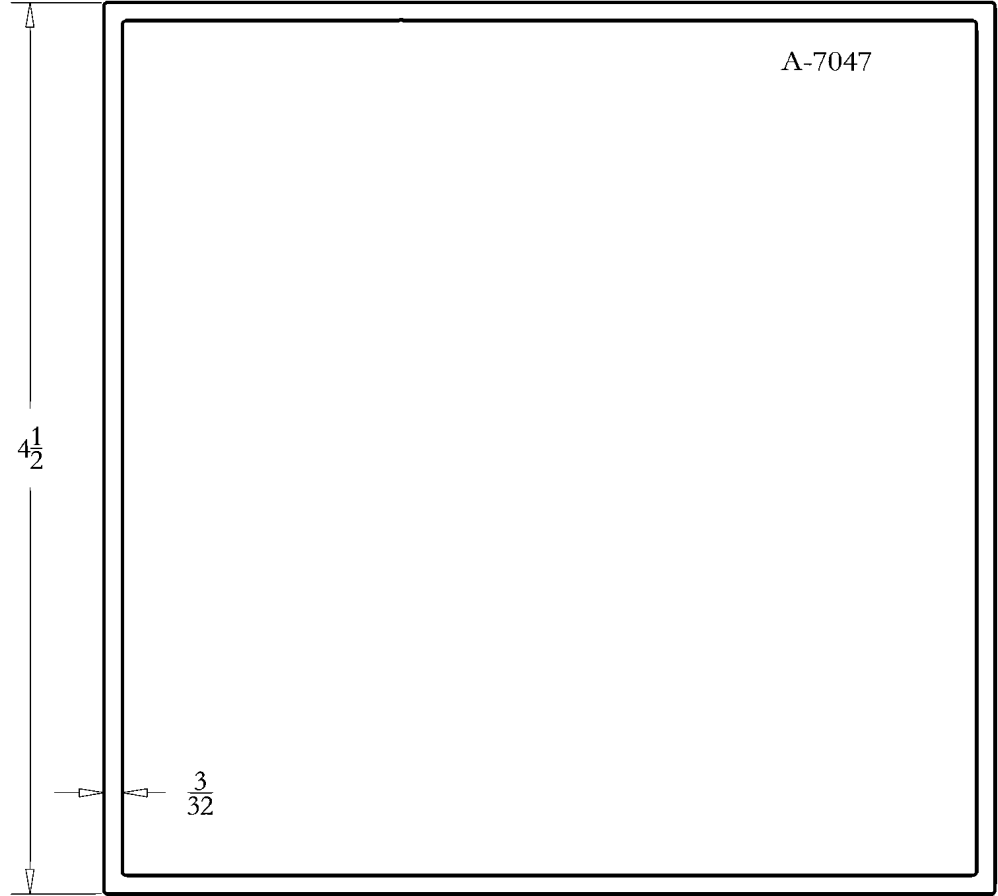
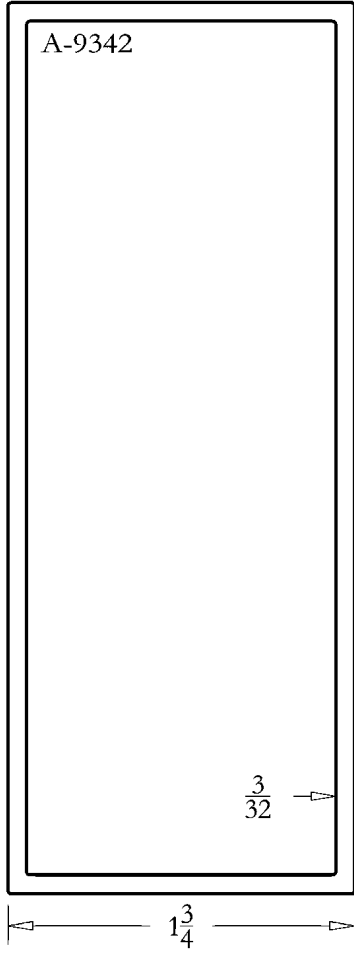

FULL SIZE DETAILS

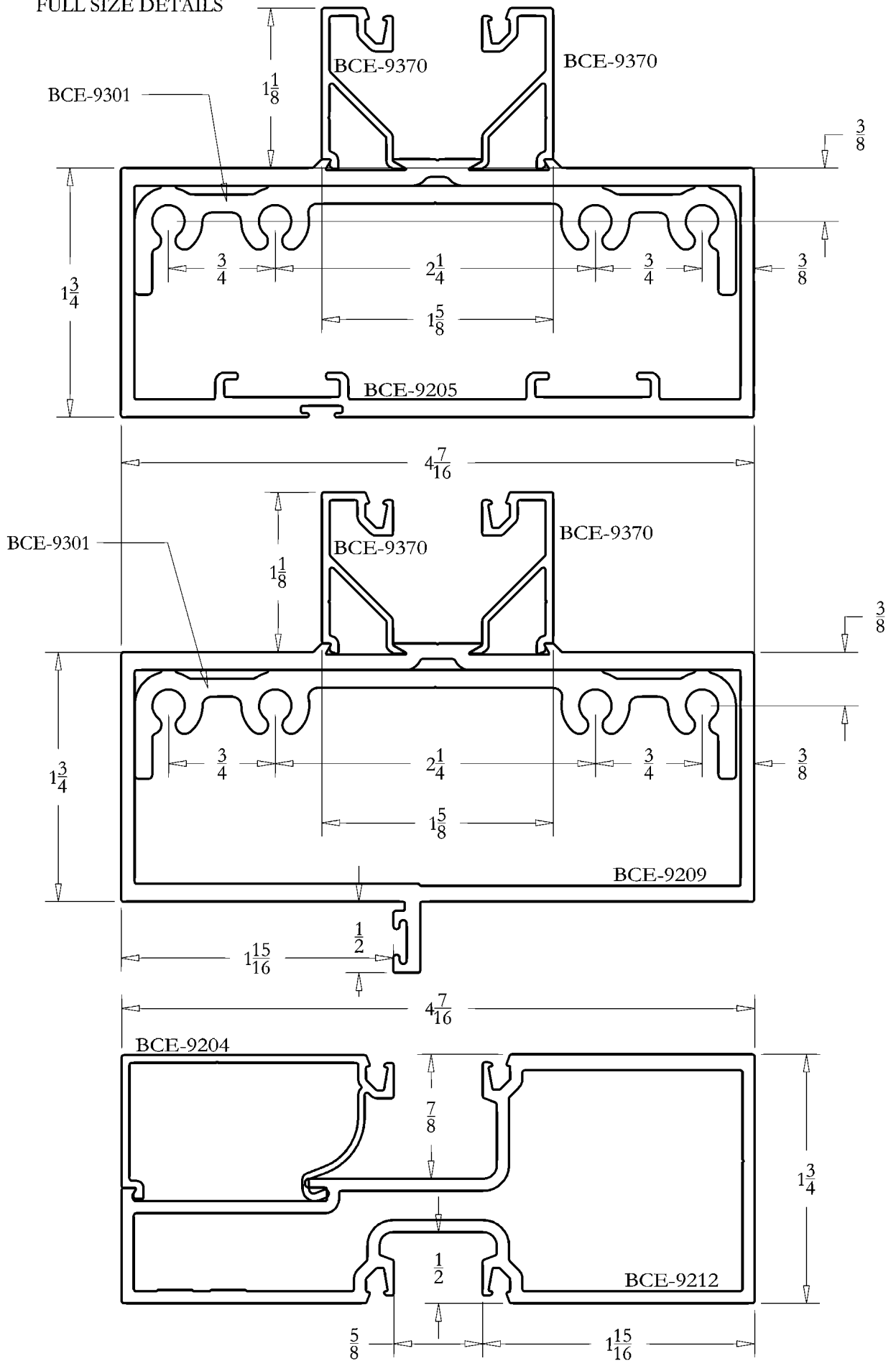

DETAIL SHEET  
 1 3/4" x 4 1/2" FLUSH GLAZED  
 BCE-9200 SERIES

FULL SIZE DETAILS

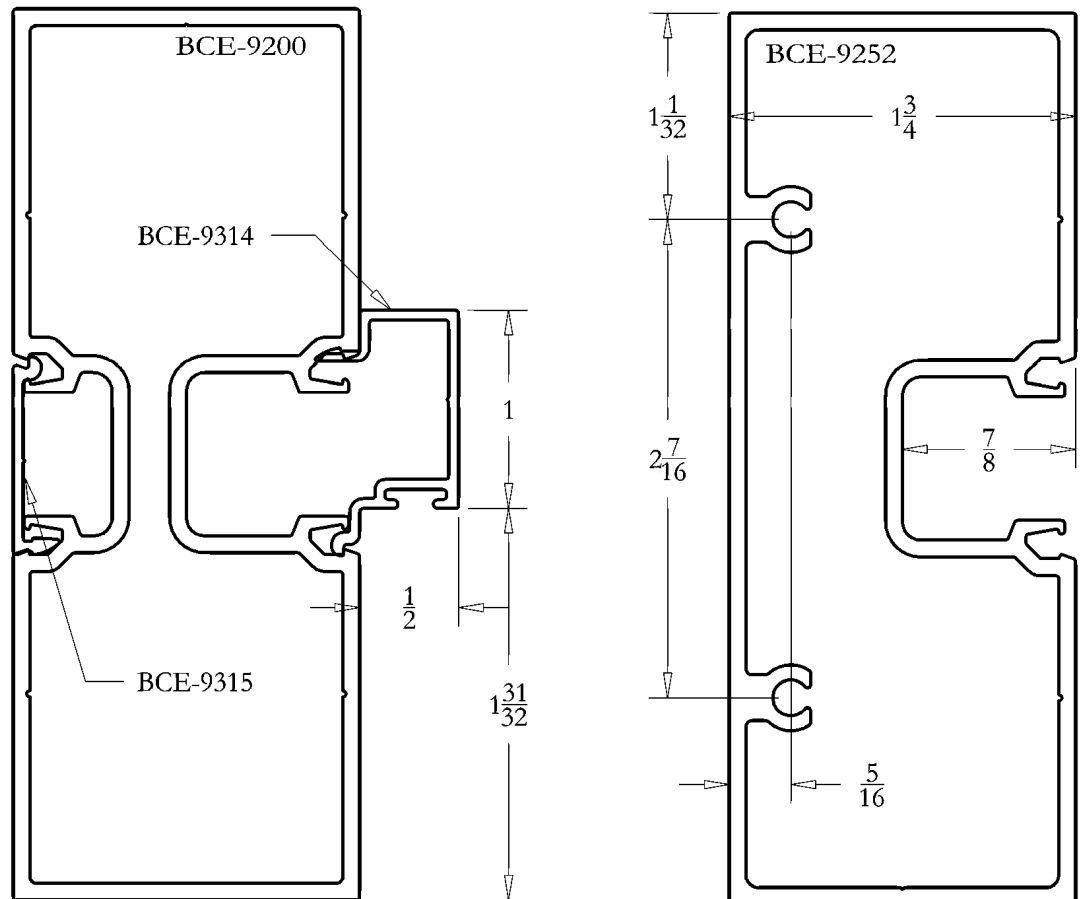
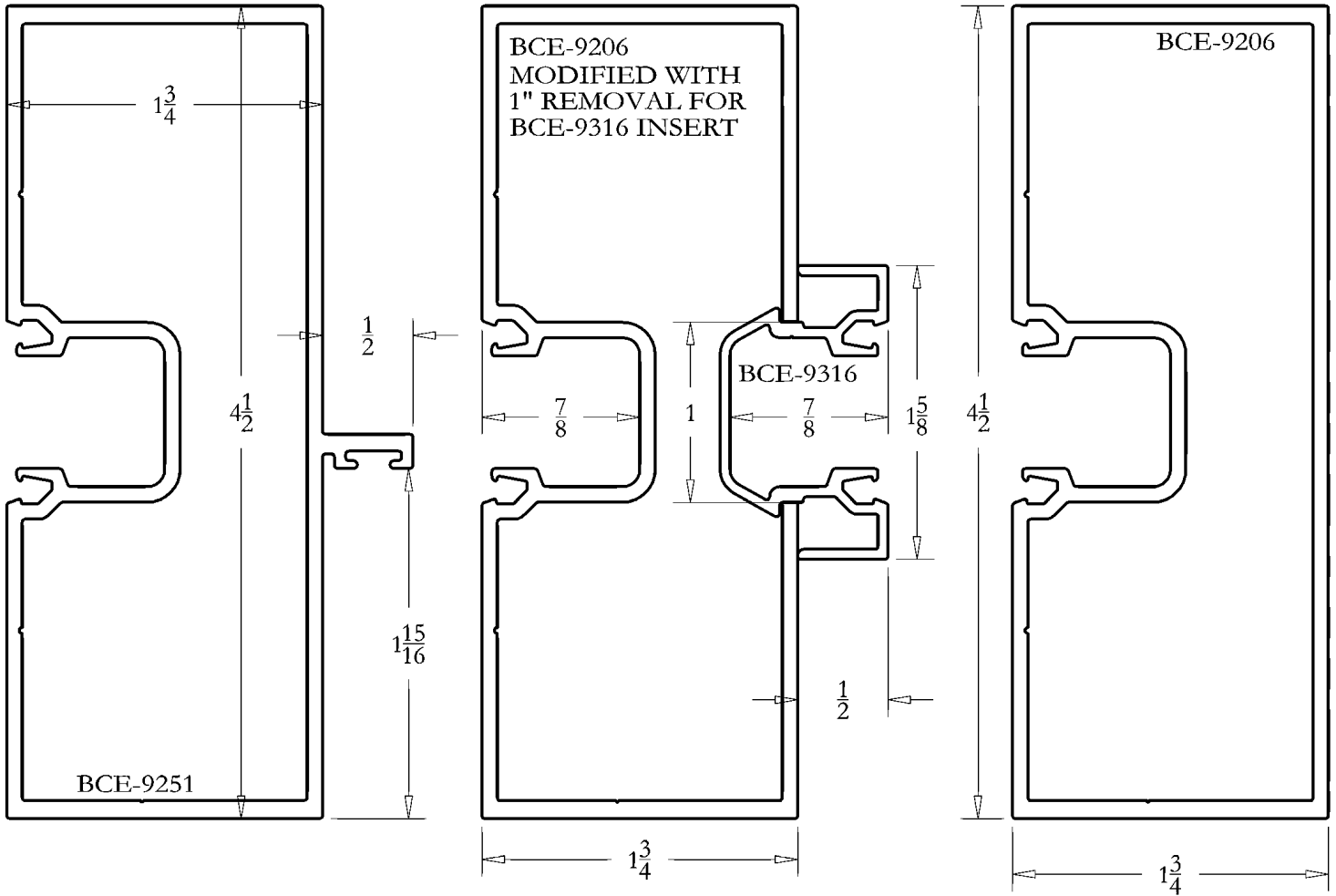

NOTE: IN THE EVENT THAT BCE-9315 DOES NOT SNAP INTO PLACE, IT IS UP TO THE INSTALLING MECHANIC TO DEFORM THE SNAP OR SILICONE THE COVER IN PLACE.