

2200 SERIES ENTRANCE DOOR TYPES/SECTION DIMENSIONS



NARROW STYLE

MEDIUM STYLE

WIDE STYLE

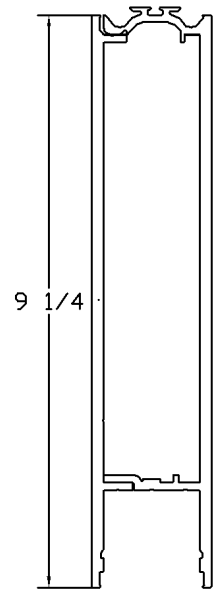
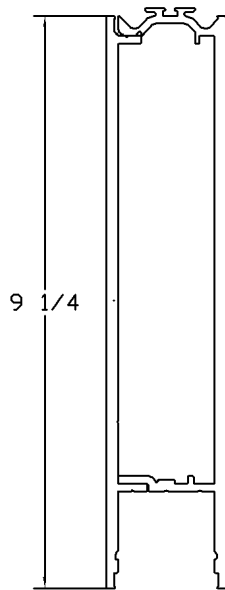
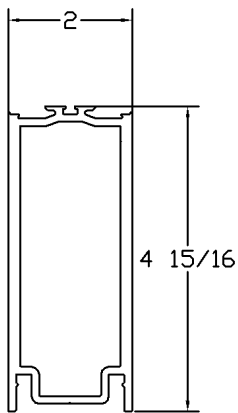
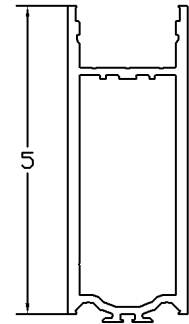
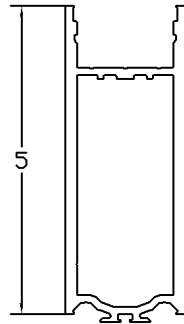
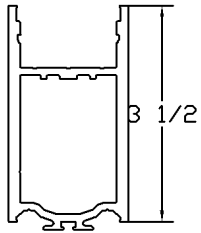
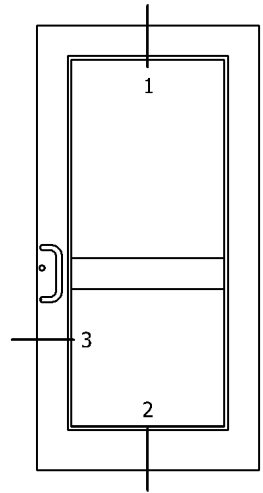
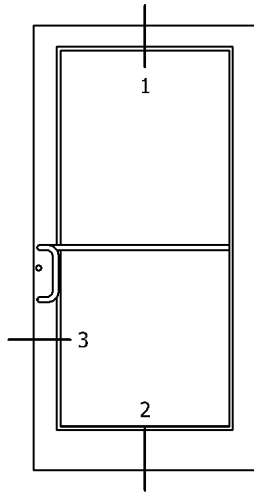
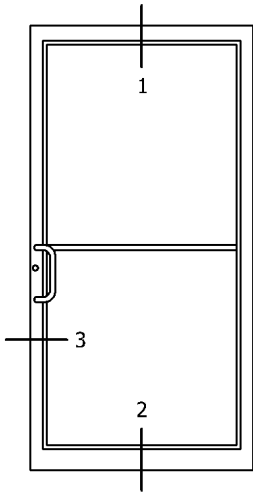

SINGLE ACTING

DOUBLE ACTING

DOUBLE ACTING

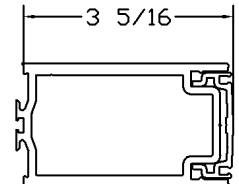
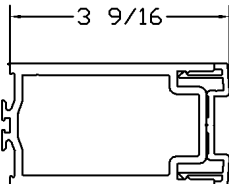
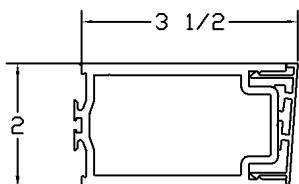

2200 SERIES ENTRANCE
DOOR

PART NUMBER	DIE DRAWING	WT/FT	PERMIETER	X-X	Y-Y
BCE-2211		2.107	14.543	1.985 I 1.024 S	1.068 1.102
BCE-2214		2.084	14.157	1.097 I 1.097 S	2.161 1.256
BCE-2221		2.783	28.168	1.501 I 1.549 S	5.567 2.089
BCE-2222		2.682	27.448	19.571 I 3.980 S	0.412 0.272
BCE-2223		2.174	20.646	13.122 I 2.821 S	0.017 0.031
BCE-2224		2.761	29.009	5.848 I 2.365 S	1.562 1.562
BCE-2230		0.204	4.759	0.008 I 0.019 S	0.015 0.035
BCE-2234		0.352	9.130	0.009 I 0.017 S	0.101 0.091
BCE-2235		0.408	8.527	0.012 I 0.021 S	0.142 0.142
BCE-2236		0.192	6.848	0.010 I 0.022 S	0.107 0.125
BCE-2237		0.192	4.505	0.005 I 0.010 S	0.022 0.038
BCE-2238		0.484	3.557	0.073 I 0.095 S	0.003 0.017
BCE-2239		0.392	6.727	0.078 I 0.094 S	0.008 0.020
BCE-2246		1.615	11.367	0.394 I 0.515 S	0.349 0.352

2200 SERIES ENTRANCE
DOOR

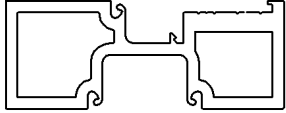
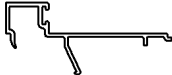
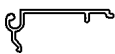
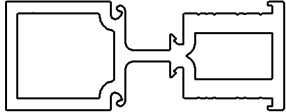
PART NUMBER	DIE DRAWING	WT/FT	PERMIETER	X-X Y-Y
BCE-1490		3.224	17.182	5.867 I 0.859 2.523 S 0.945
BCE-1491		0.340	9.787	0.172 I 0.019 0.104 S 0.027
BCE-1492		0.187	5.539	0.047 I 0.004 0.044 S 0.008
BCE-1493		3.434	17.255	6.045 I 0.873 2.509 S 0.997

2200 SERIES ENTRANCE
NARROW STILE DOOR

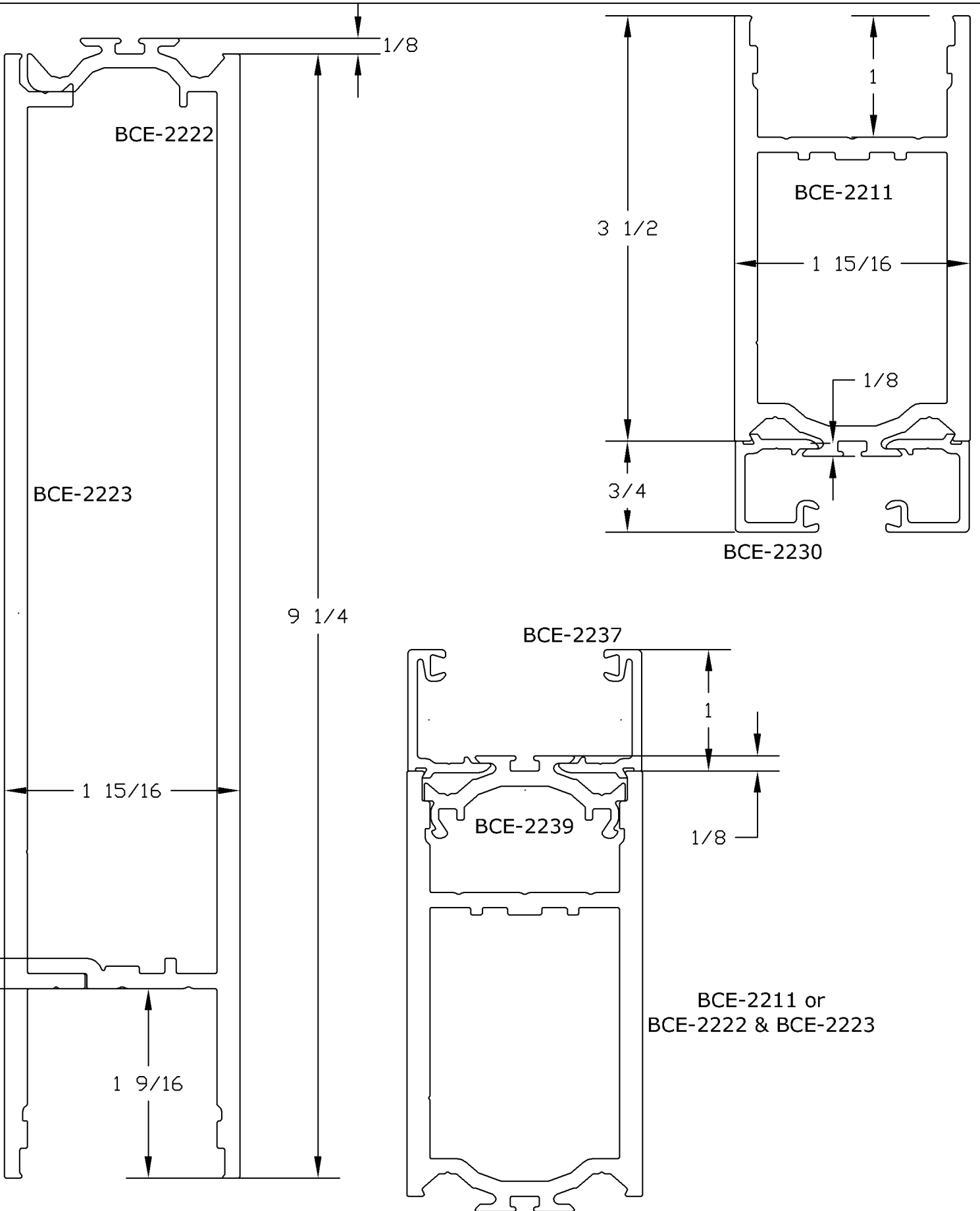

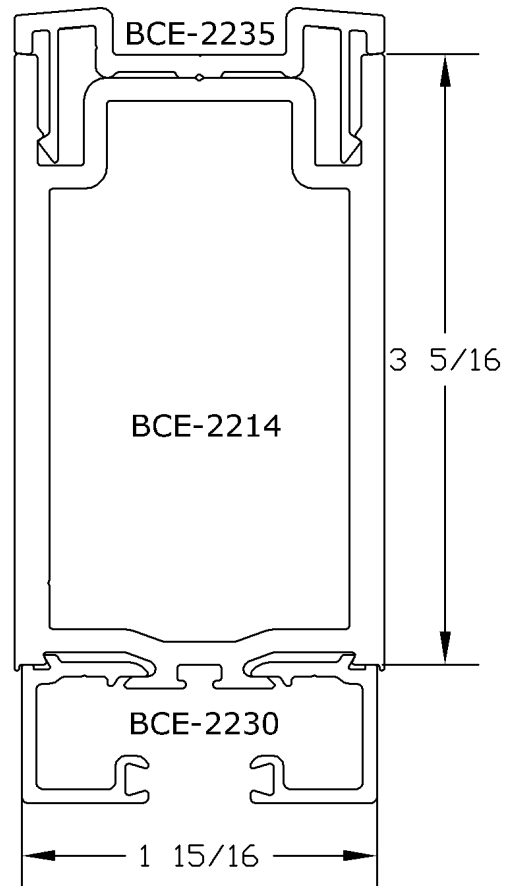
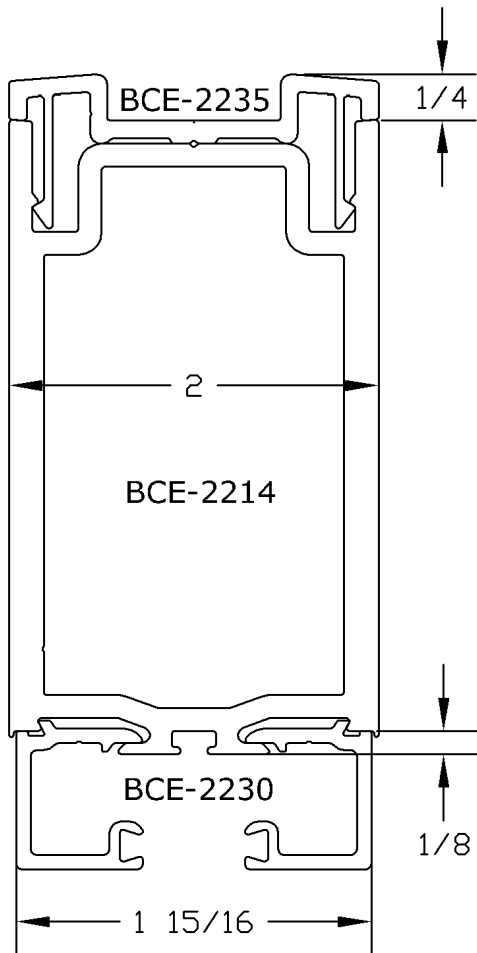
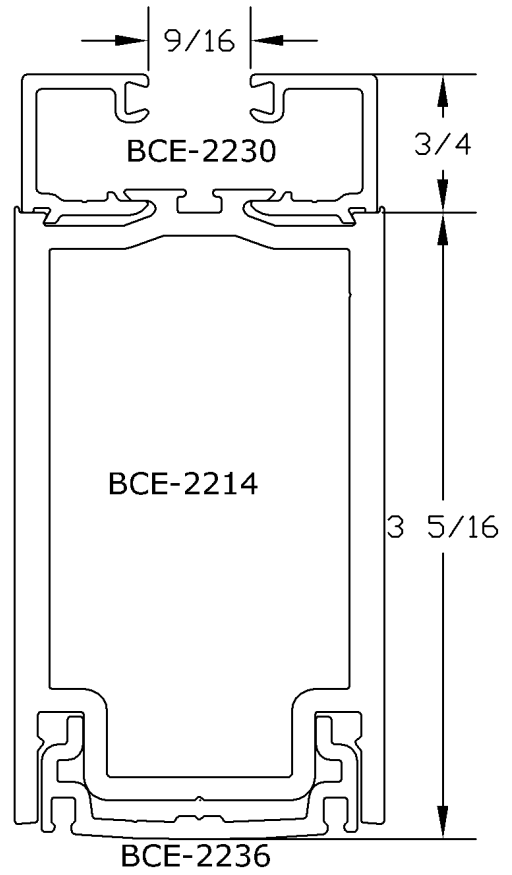
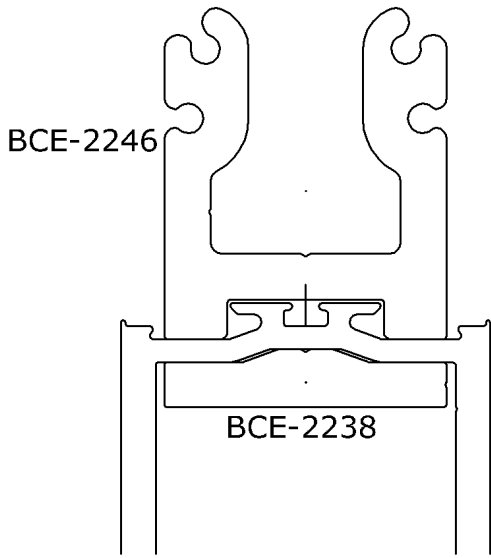

2200 SERIES ENTRANCE
NARROW STILE DOOR

