

1/4 SIZE DETAILS

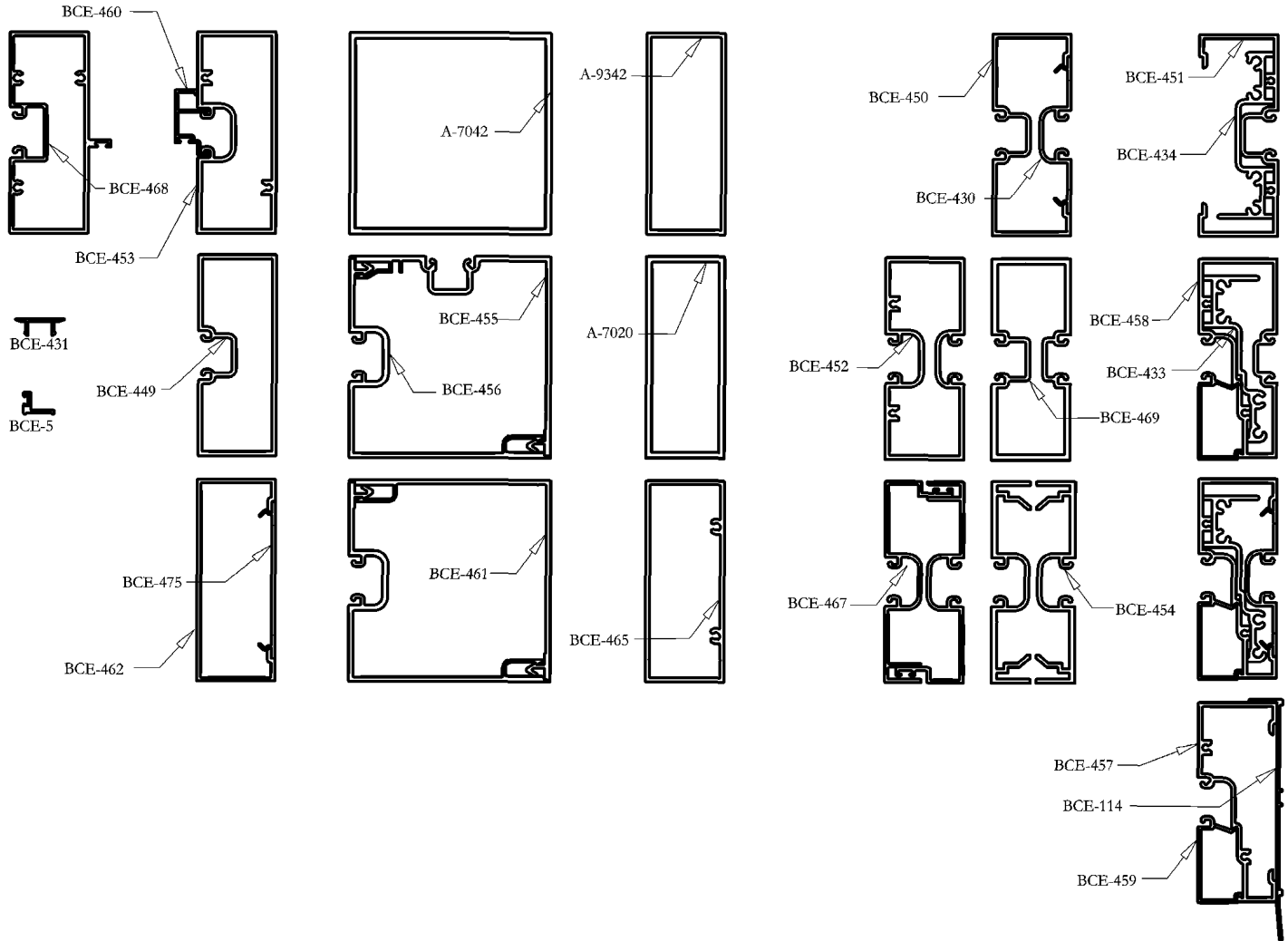

THIS SYSTEM IS DESIGNED TO BE ASSEMBLED WITH #8 SCREWS EXCEPT WHERE NOTED

GASKETS

UNIVERSAL RUBBER COMPANY 800-782-2375	#2028	INTERIOR & EXTERIOR
REED RUBBER PRODUCTS 800-325-9698	#3734 #4893	INTERIOR & EXTERIOR ALTERNATIVE
TREMCO 800-321-6357	TR-2062E	INTERIOR & EXTERIOR

DOOR PILE



SCHLEGEL CORP. 800-828-6237	AS SELECTED	USED WITH BCE-5 AND LIKE SHAPES
AMESBURY GROUP INC. 704-878-6892	AS SELECTED	USED WITH BCE-5 AND LIKE SHAPES

NO TEST DATA AVAILABLE
 TREDEGAR EXTRUSIONS INC. DOES NOT MAKE ANY WARRANTY EXPRESS OR IMPLIED INCLUDING
 NO WARRANTY OF MERCHANTABILITY OR FITNESS FOR A PARTICULAR PURPOSE AND RESERVES
 THE RIGHT TO MAKE CHANGES
 REPRODUCTION RIGHTS RESERVED

PRICING FACTORS
1 3/4" X 4 1/2" FLUSH GLAZED
BCE-450 SERIES

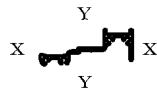
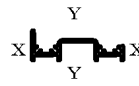
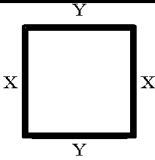
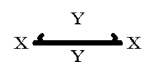

WEIGHT PER FT	EST PER	FACTOR	CAVITY AREA	PART NUMBER	STRUCTURAL VALUES			1/8 SIZE DETAILS
					X-X	Y-Y		
1.152	22.364	19	N/A	BCE450	0.353	I	2.436	
					0.313	S	1.083	
1.302	23.816	18	N/A	BCE451	0.379	I	2.743	
					0.329	S	1.219	
1.898	18.180	18	N/A	BCE452	0.671	I	3.103	
					0.741	S	1.379	
1.716	15.536	17	N/A	BCE453	0.675	I	3.062	
					0.756	S	1.361	
1.210	20.087	17	N/A	BCE454	0.079	I	2.228	
					0.141	S	0.990	
1.486	25.304	17	N/A	BCE455	2.486	I	2.660	
					0.761	S	0.878	
1.584	25.784	16	N/A	BCE456	2.735	I	2.569	
					0.914	S	0.782	
1.110	20.116	18	N/A	BCE457	0.289	I	2.227	
					0.311	S	0.911	
1.558	14.846	18	N/A	BCE458	0.446	I	2.425	
					0.431	S	1.017	
0.295	8.202	28	N/A	BCE459	0.021	I	0.129	
					0.030	S	0.132	
0.251	7.076	28	N/A	BCE460	0.010	I	0.043	
					0.020	S	0.056	
1.267	21.440	17	N/A	BCE461	2.454	I	2.503	
					0.770	S	0.791	
0.955	18.650	20	N/A	BCE462	0.363	I	2.400	
					0.316	S	1.067	
0.552	12.277	22	N/A	BCE430	0.025	I	0.395	
					0.055	S	0.226	

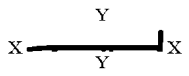
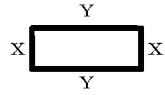
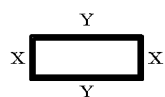
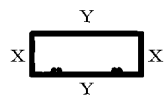
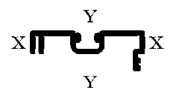
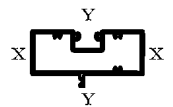
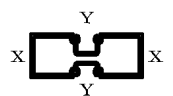
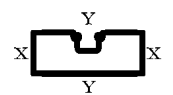
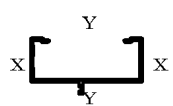
WEIGHT PER FT	EST PER	FACTOR	CAVITY AREA	PART NUMBER	STRUCTURAL VALUES			1/8 SIZE DETAILS
					X-X	Y-Y		
0.112	3.494	31	N/A	BCE431	0.001 I 0.008 0.004 S 0.015			
0.899	14.003	16	N/A	BCE433	0.106 I 1.103 0.143 S 0.518			
0.979	15.098	15	N/A	BCE434	0.058 I 1.271 0.074 S 0.636			
2.626	17.973	13	N/A	A7043	6.984 I 6.984 3.104 S 3.104			
0.370	8.473	23	N/A	BCE475	0.001 I 0.356 0.003 S 0.203			
0.109	2.712	25	N/A	BCE5	0.002 I 0.004 0.006 S 0.009			
0.474	12.592	27	N/A	BCE114	0.006 I 1.116 0.010 S 0.375			
1.368	12.473	18	N/A	A9342	0.640 I 2.853 0.731 S 1.268			
1.800	12.488	13	N/A	A7020	0.814 I 3.693 0.930 S 1.641			
1.464	12.473	18	N/A	BCE465	0.676 I 2.973 0.734 S 1.321			
0.943	20.196	21	N/A	BCE467	0.111 I 1.758 0.100 S 0.748			
1.656	17.044	19	N/A	BCE468	0.697 I 2.858 0.521 S 1.260			
2.081	17.268	15	N/A	BCE469	0.753 I 3.752 0.856 S 1.668			
1.588	14.988	18	N/A	BCE449	0.635 I 2.918 0.713 S 1.297			
1.069	19.896	19	N/A	BCE463	0.413 I 2.580 0.346 S 1.140			

WINDLOAD CHARTS
1 3/4" X 4 1/2" FLUSH GLAZED
BCE-450 SERIES

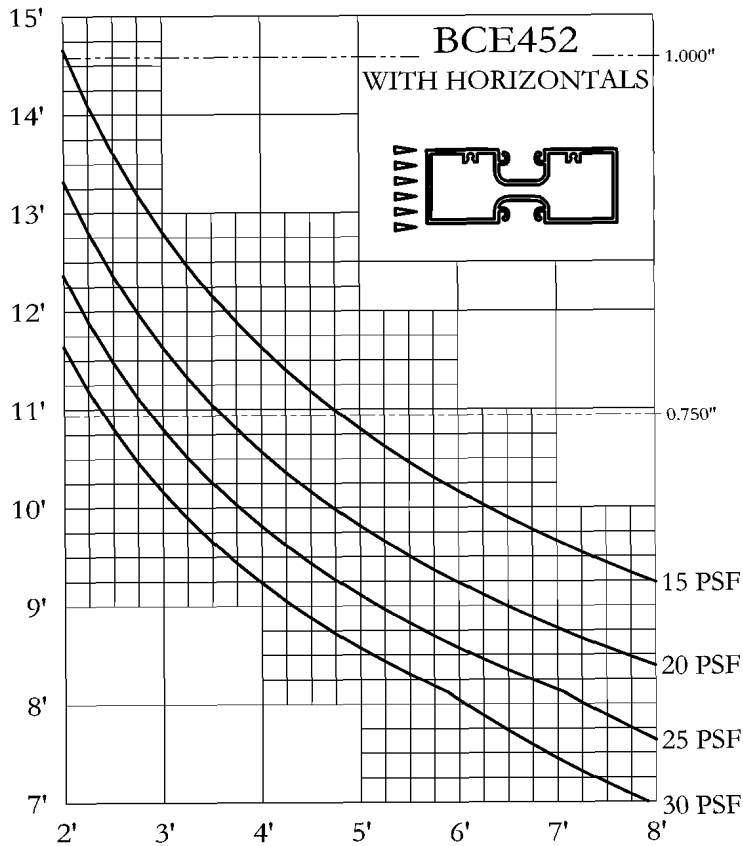
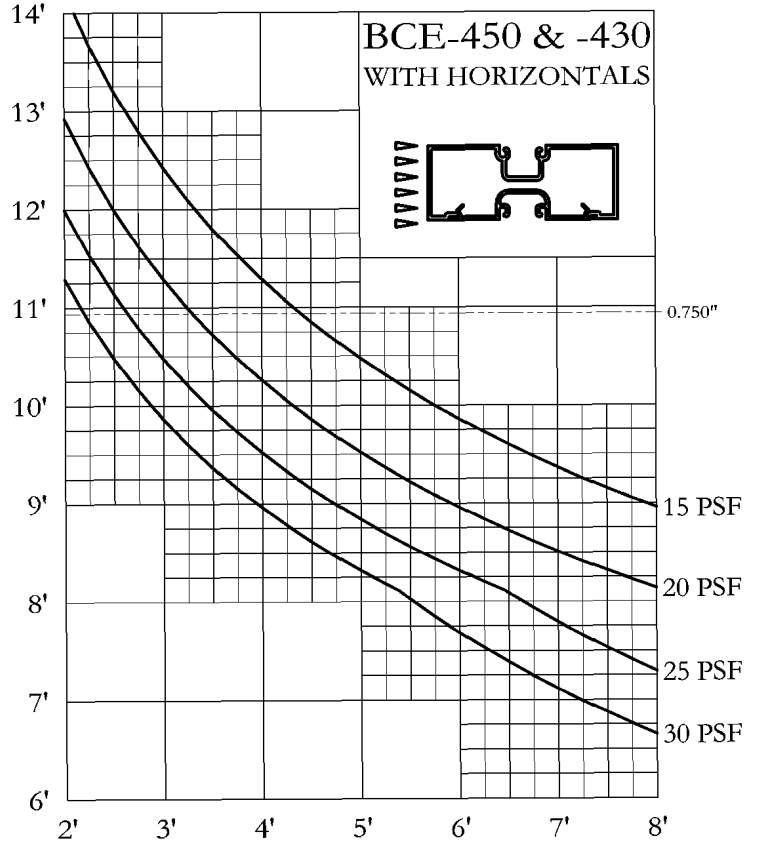
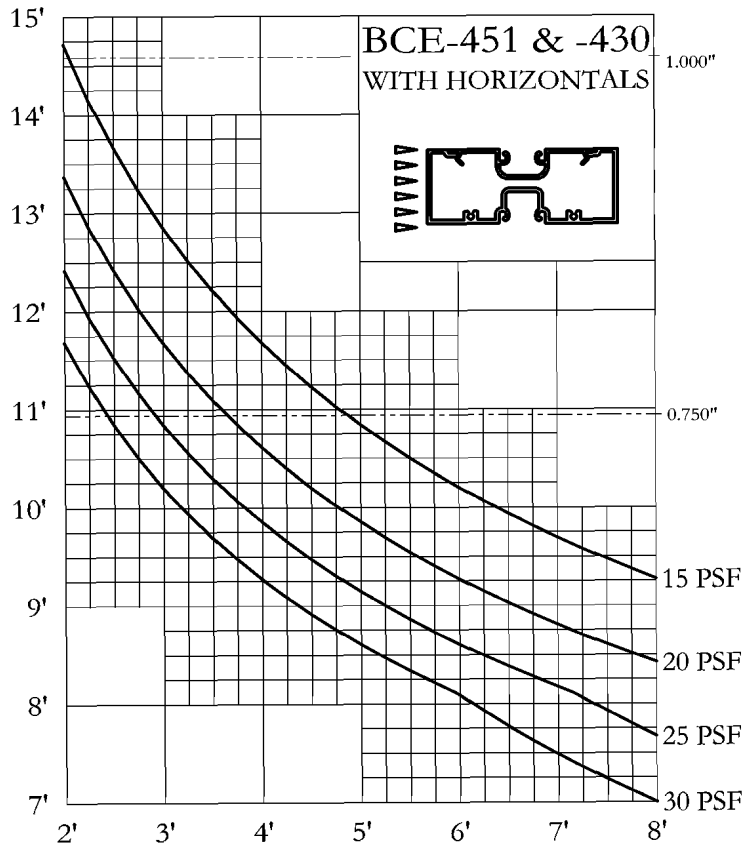

#1 THESE WINDLOAD CHARTS ARE BASED UPON THE LESSER OF DEFLECTION RATIO (L/175) OR STRESS (12667)

#2 THESE STRUCTURAL CURVES ARE ESTIMATES AND ARE PRESENTED TO THE BEST KNOWLEDGE OF THE WILLIAM L BONNELL CO. IT IS, HOWEVER, THE RESPONSIBILITY OF THE CUSTOMER TO BE SATISFIED THAT THE CURVES ARE CORRECT. THE WILLIAM L BONNELL CO. MAY NOT BE HELD RESPONSIBLE IN ANY WAY FOR THE FAILURE OF PERFORMANCE RESULTING FROM THE USE OF THESE CURVES.

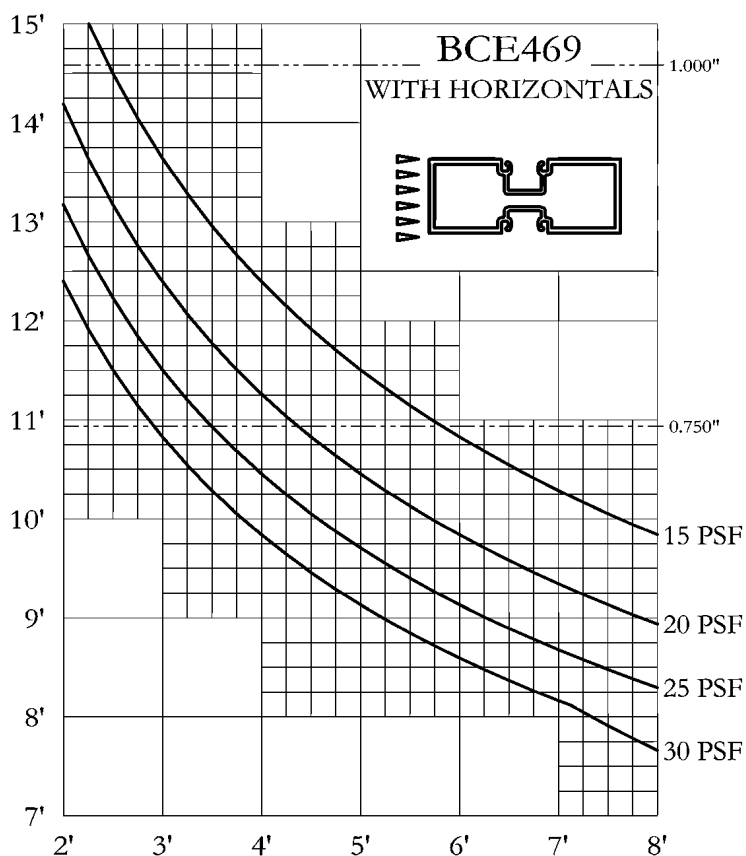
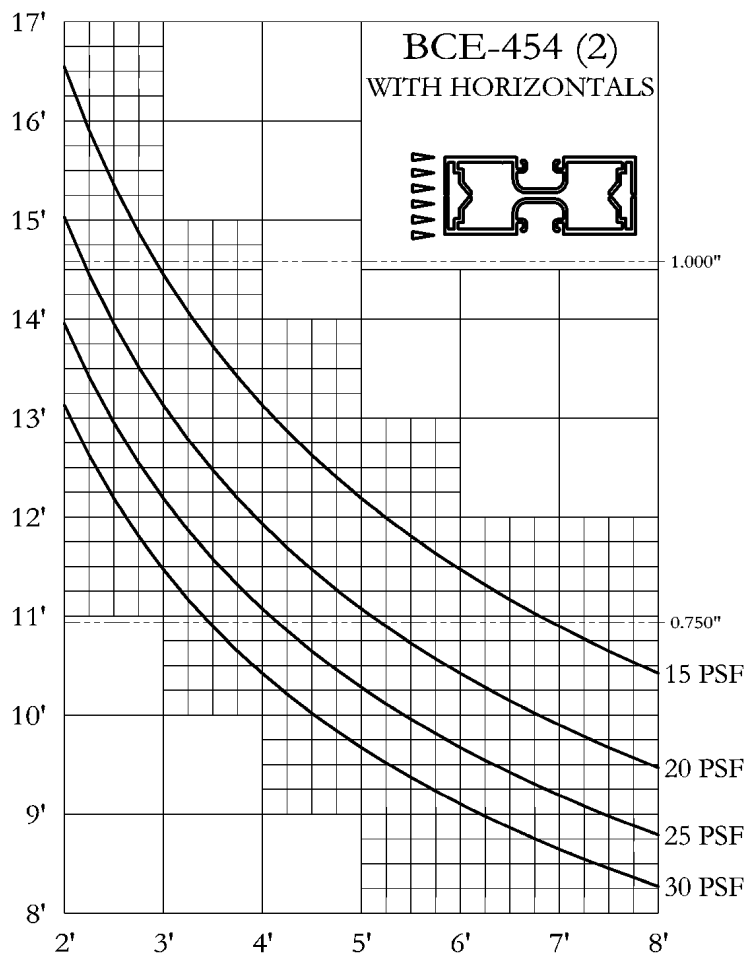
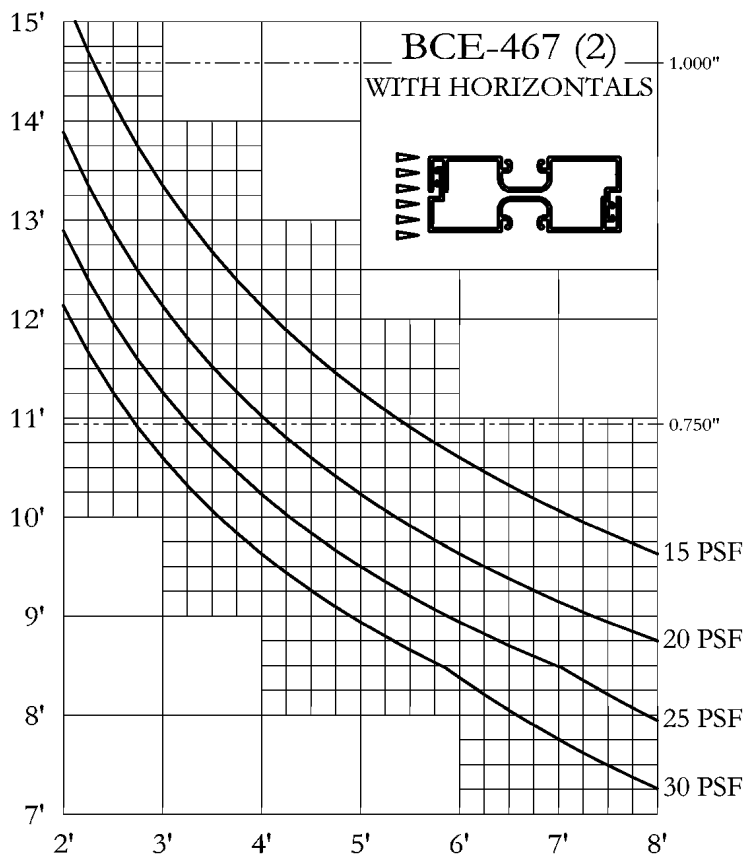

#1 THESE WINDLOAD CHARTS ARE BASED UPON THE LESSER OF DEFLECTION RATIO (L/175) OR STRESS (12667)

#2 THESE STRUCTURAL CURVES ARE ESTIMATES AND ARE PRESENTED TO THE BEST KNOWLEDGE OF THE WILLIAM L BONNELL CO. IT IS, HOWEVER, THE RESPONSIBILITY OF THE CUSTOMER TO BE SATISFIED THAT THE CURVES ARE CORRECT. THE WILLIAM L BONNELL CO. MAY NOT BE HELD RESPONSIBLE IN ANY WAY FOR THE FAILURE OF PERFORMANCE RESULTING FROM THE USE OF THESE CURVES.

WINDLOAD CHARTS
1 3/4" X 4 1/2" FLUSH GLAZED
BCE-450 SERIES

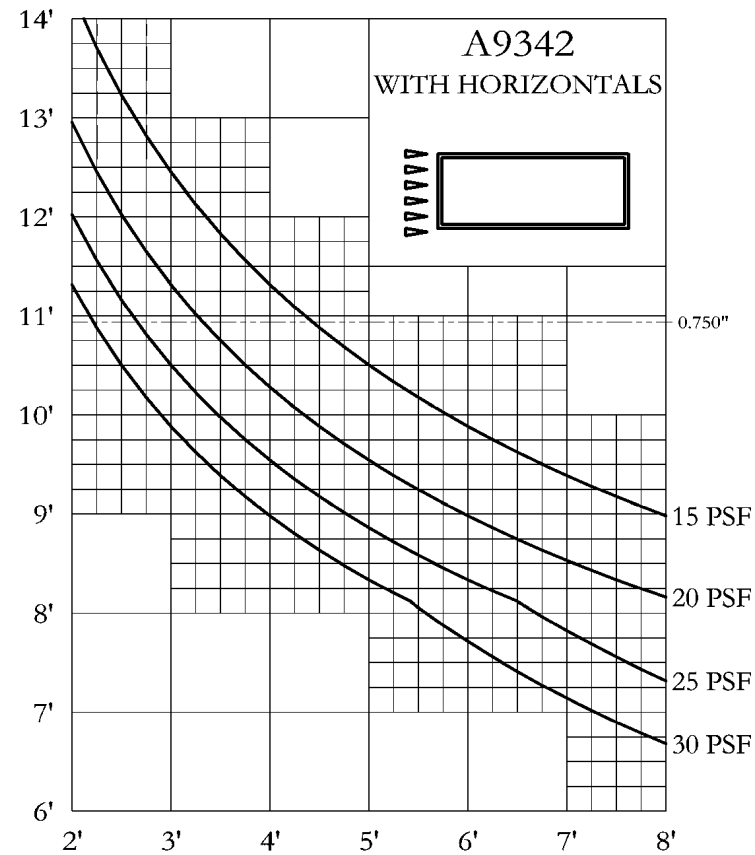
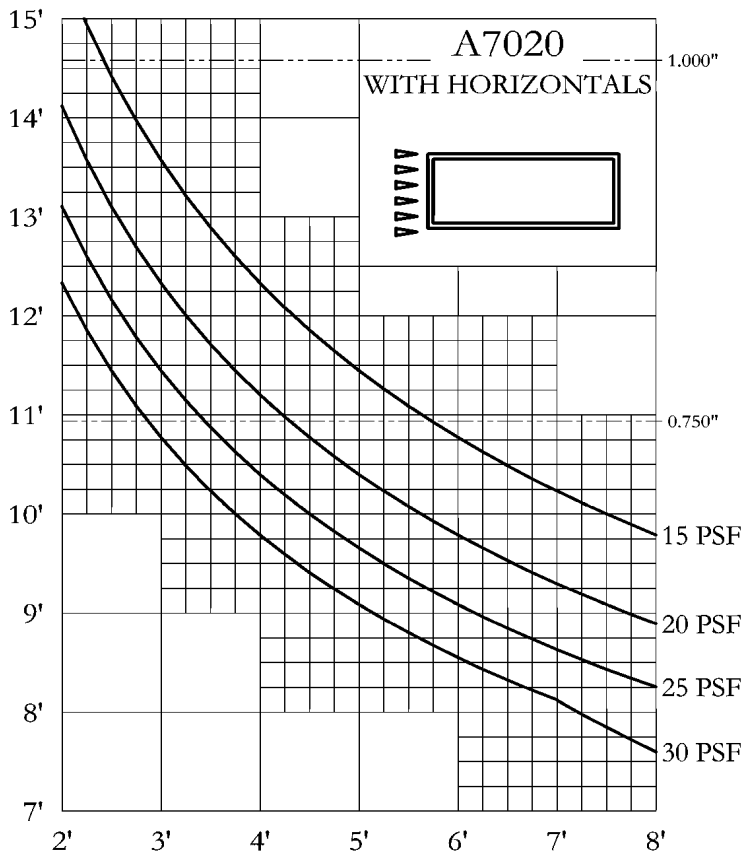
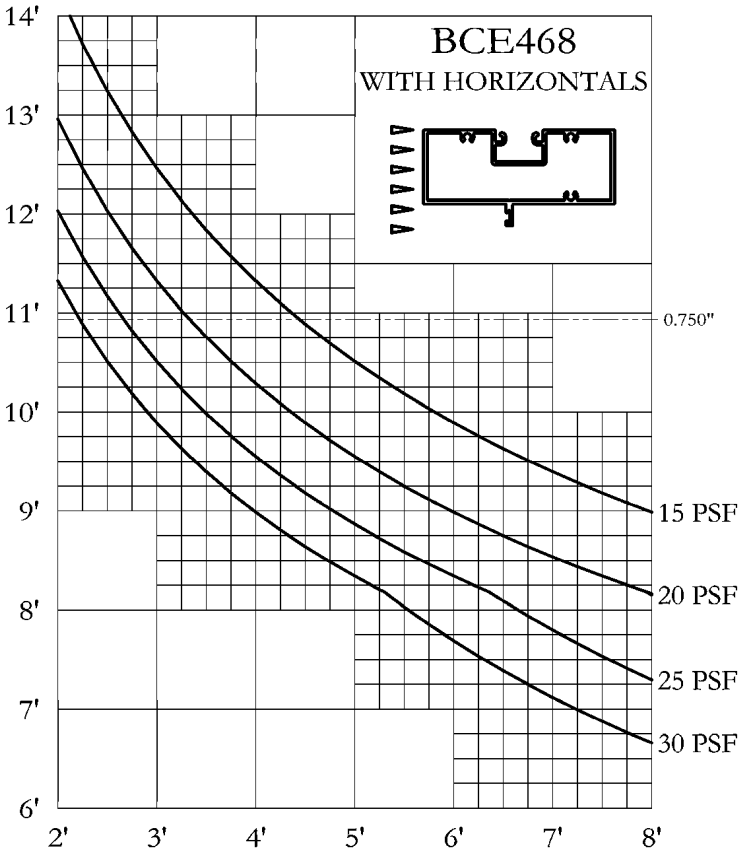
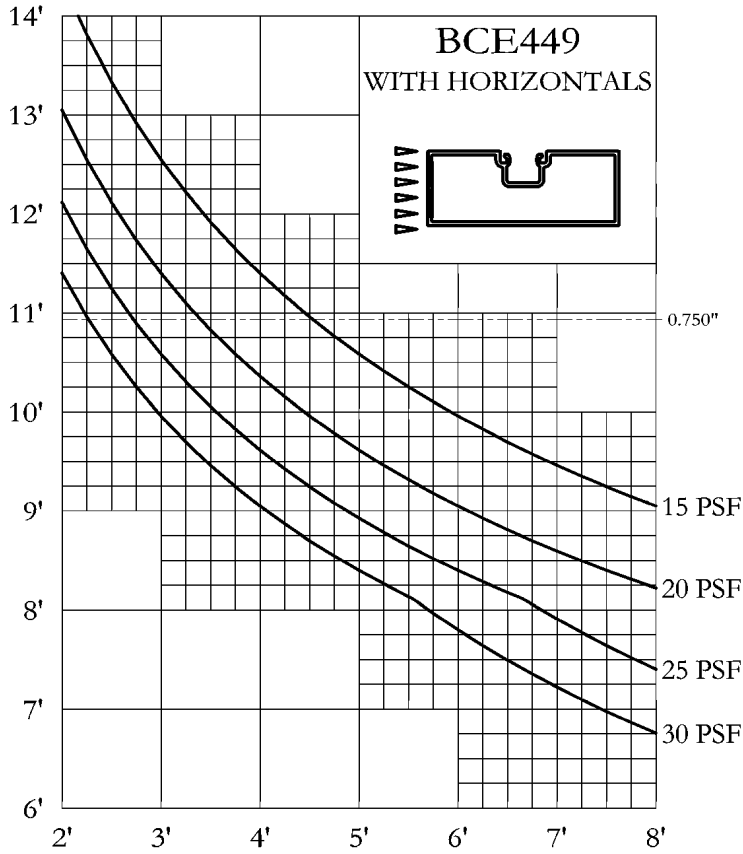

#1 THESE WINDLOAD CHARTS ARE BASED UPON THE LESSER OF DEFLECTION RATIO (L/175) OR STRESS (12667)

#2 THESE STRUCTURAL CURVES ARE ESTIMATES AND ARE PRESENTED TO THE BEST KNOWLEDGE OF THE WILLIAM L BONNELL CO. IT IS, HOWEVER, THE RESPONSIBILITY OF THE CUSTOMER TO BE SATISFIED THAT THE CURVES ARE CORRECT. THE WILLIAM L BONNELL CO. MAY NOT BE HELD RESPONSIBLE IN ANY WAY FOR THE FAILURE OF PERFORMANCE RESULTING FROM THE USE OF THESE CURVES.

FULL SIZE DETAILS

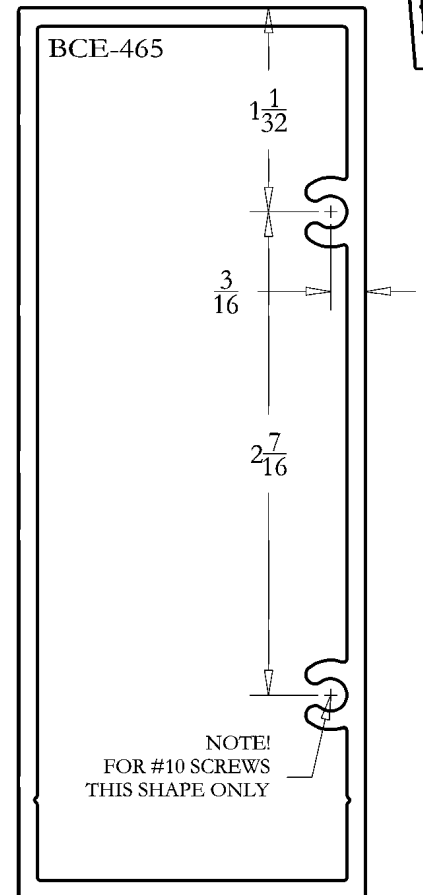
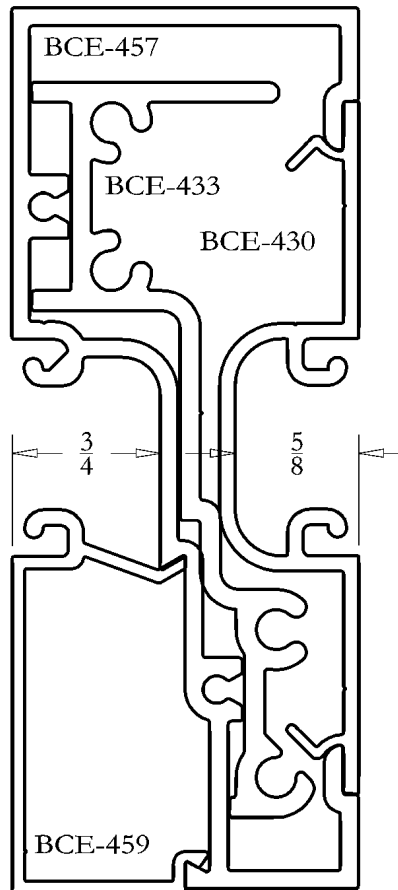
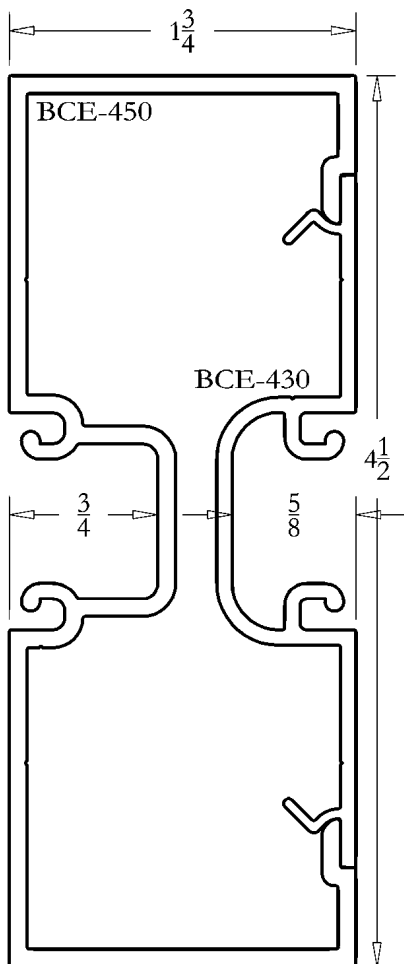
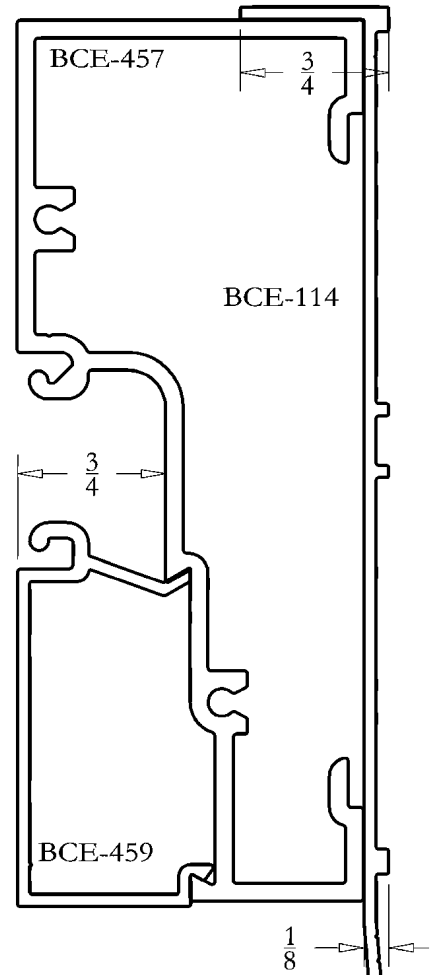
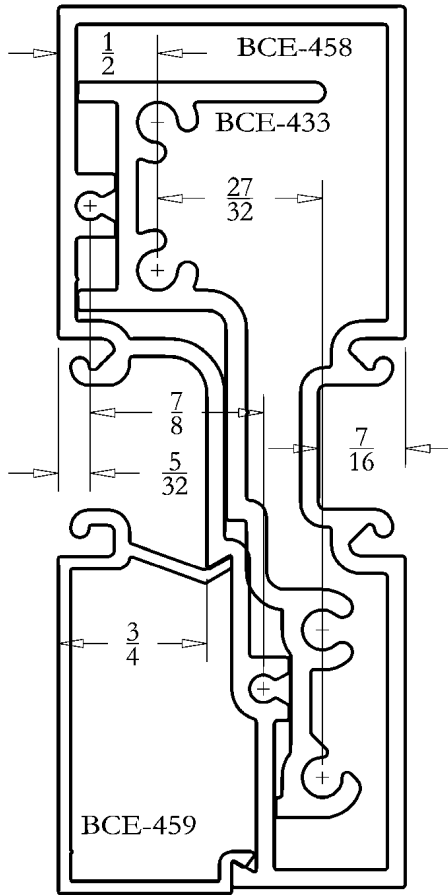
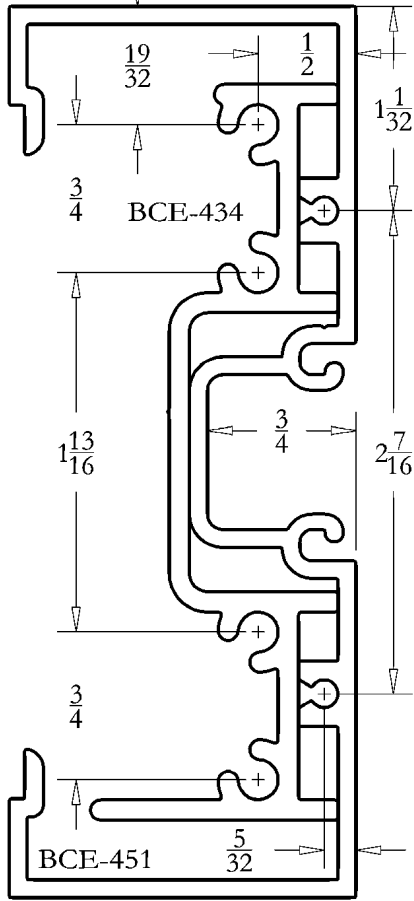

FULL SIZE DETAILS

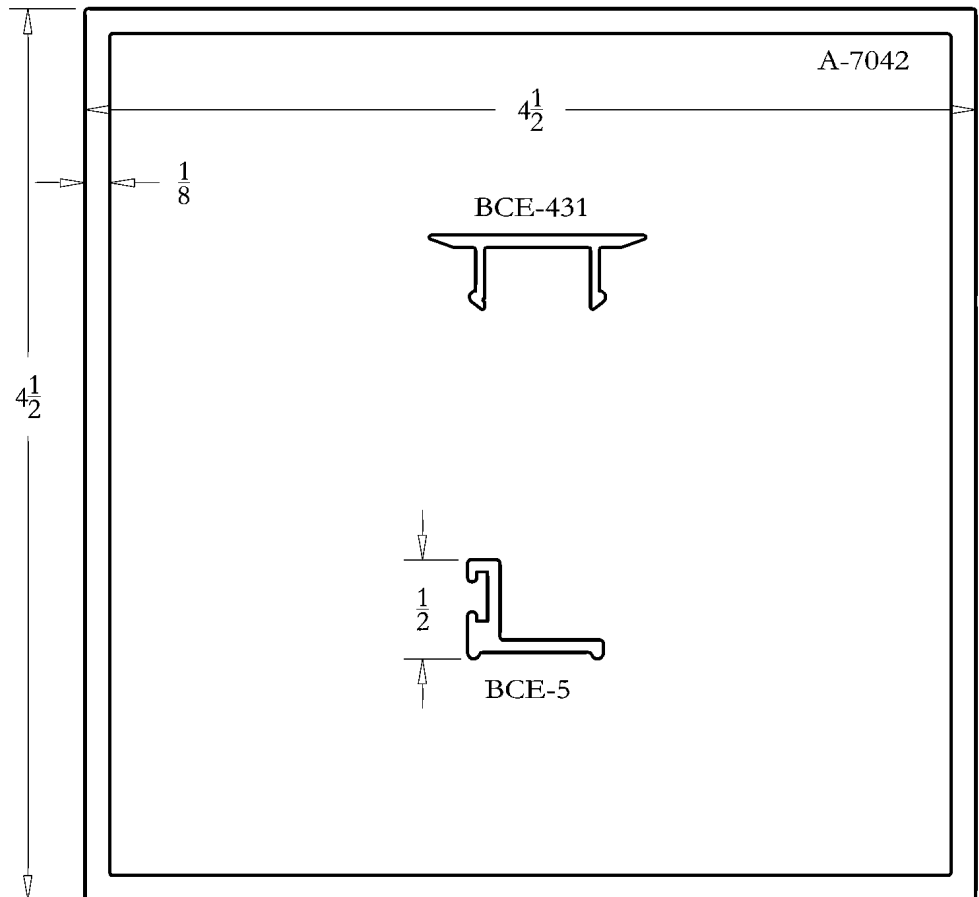
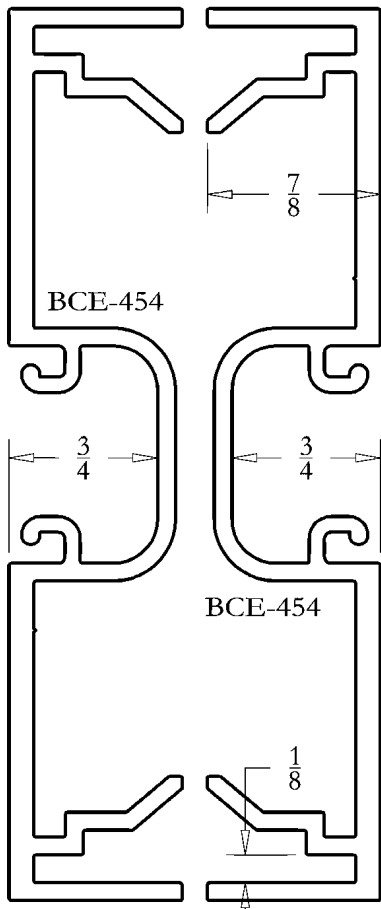
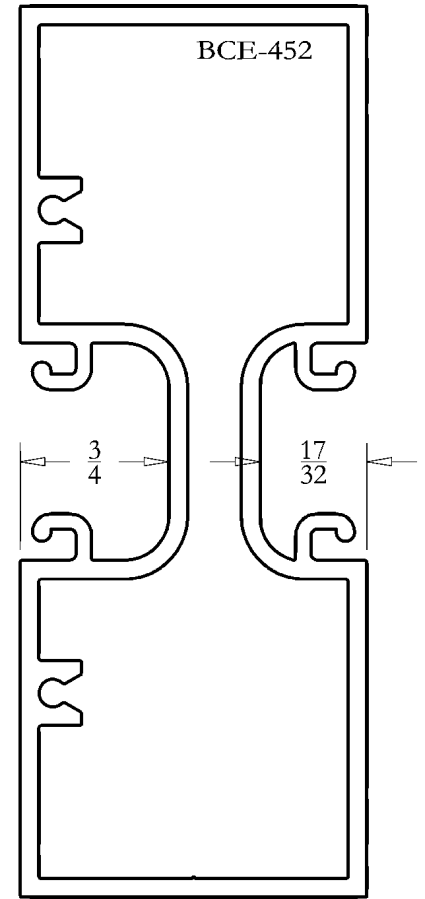
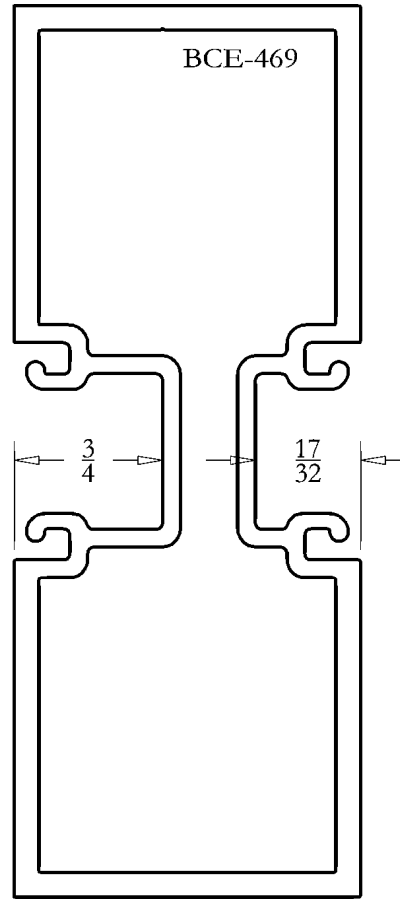
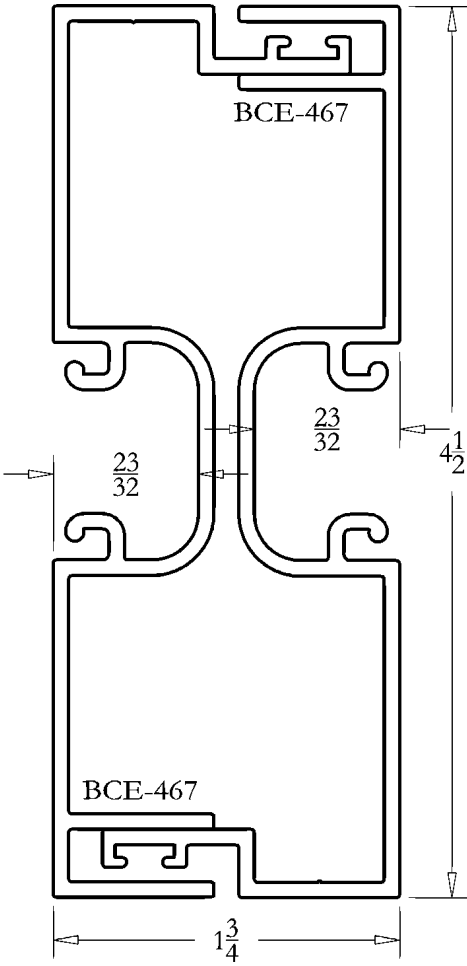

FULL SIZE DETAILS

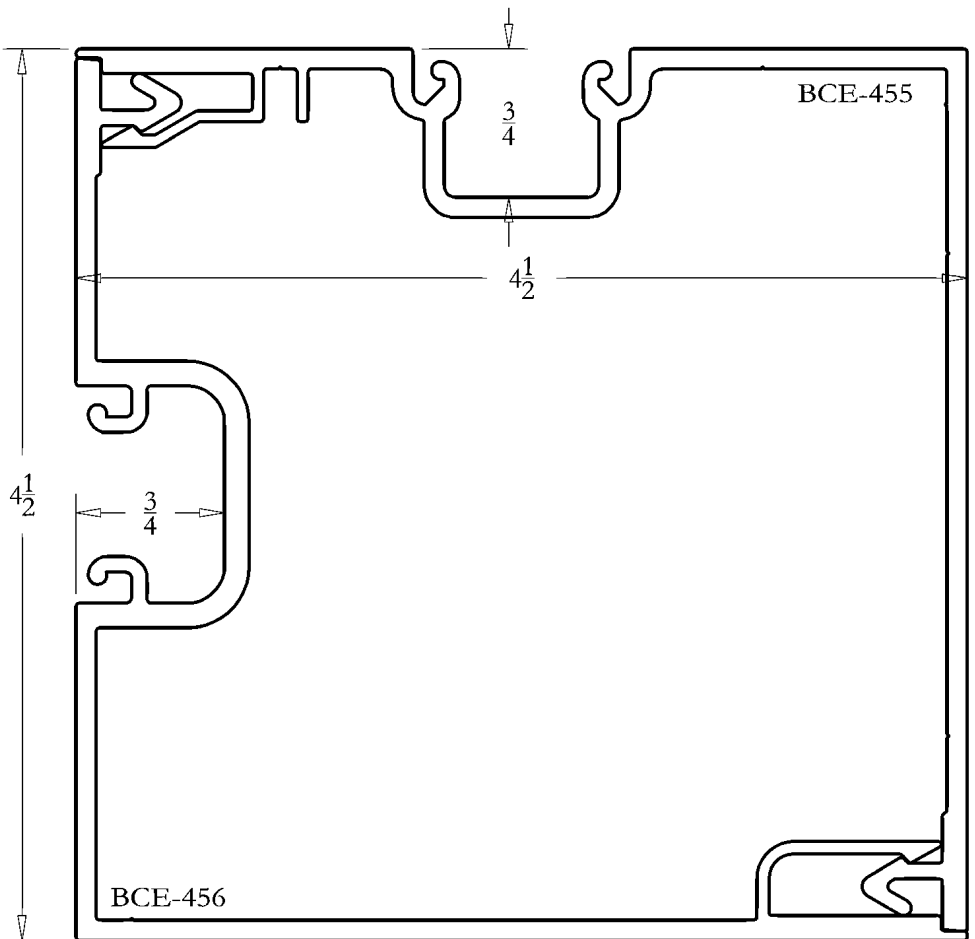
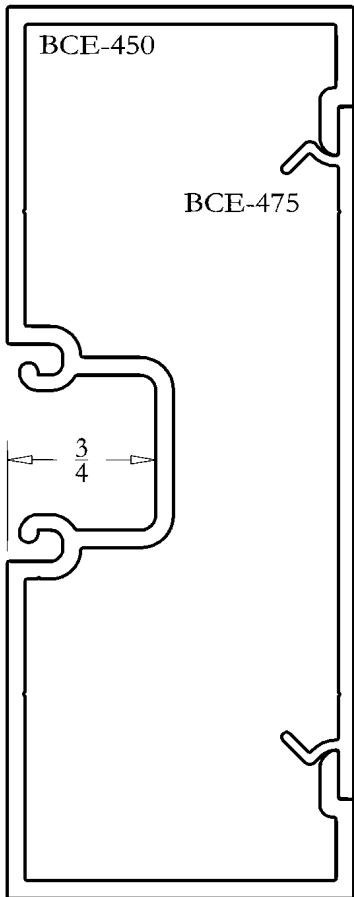
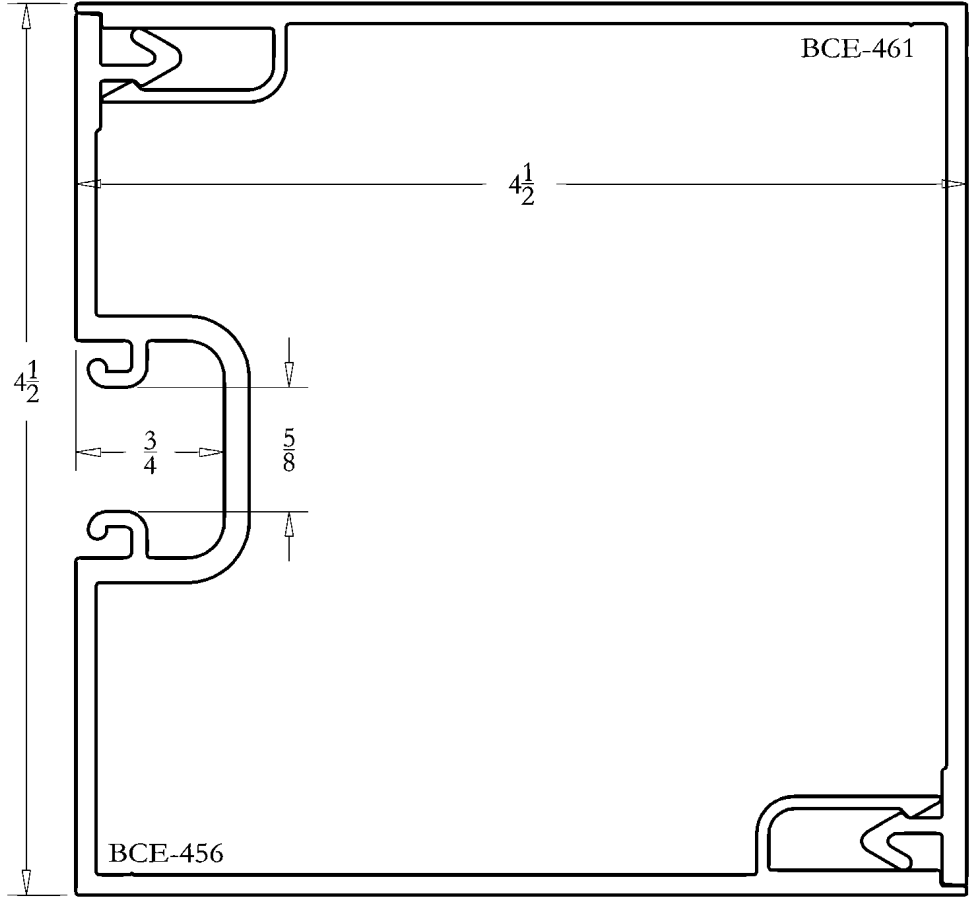
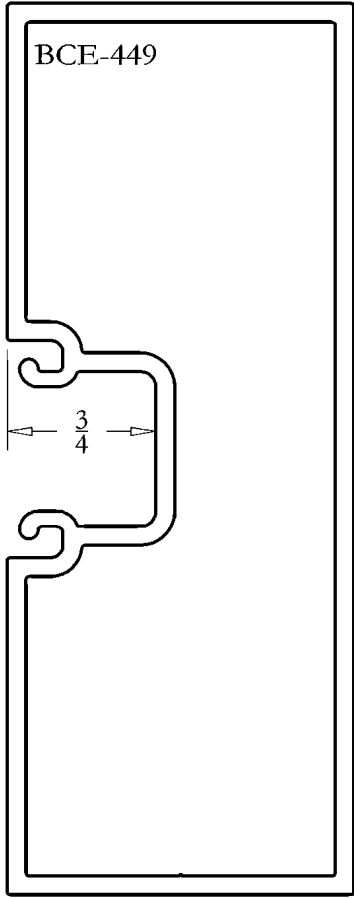

DETAIL SHEET
1 3/4" X 4 1/2" FLUSH GLAZED
BCE-450

FULL SIZE DETAILS

