















| <u>SYSTEM DESCRIPTION</u> | <u>BONNELL #</u>   | <u>COMPRABLE</u><br><u>COMPETITIVE SYSTEM</u> |
|---------------------------|--|---|
| <u>1/4" GLASS</u>         | <u>FLUSH GLAZED SYSTEMS</u>  |   |
| 1 3/4" X 3 " MULLION      |  BCE-3000 SERIES<br>SD-132                    |   |
| 1 3/4" X 4 " MULLION      |  BCE-400 SERIES<br>SD-102                     |   |
| 1 3/4" X 4 1/2" MULLION   |  BCE-450 SERIES<br>SD-103                     |   |
| 1 3/4" X 4 1/2" MULLION   |  BCE-5450 SERIES<br>SD-136                    |   |
| 1 3/4" X 4 1/2" MULLION   |  BCE-9200 SERIES<br>SD-130                    | 450 SERIES                                    |
| 2 1/4" X 6" MULLION       |  BCE-6200 SERIES<br>SD-156                    |   |
| <u>1" GLASS</u>           |  |   |
| 2" X 4 " MULLION          |  BCE-1400 SERIES<br>SD-104                    |   |
| 2" X 4 1/2" MULLION       |  BCE-1450 SERIES<br>SD-106                   |   |
| 2" X 4 1/2" MULLION       |  BCE-6450 SERIES<br>SD-137                  |   |
| 2" X 4 1/2" MULLION       |  BTF-6450 SERIES<br>SD-141                  |   |
| 2" X 4 1/2" MULLION       |  BCE-1850 SERIES<br>SD-129                  | 451 SERIES                                    |
| 2" X 4 1/2" MULLION       |  BTF-1850 SERIES<br>SD-131                  | 451T SERIES                                   |
|                           | <u>MISCELLANEOUS</u>   |   |
| FACING                    |  BCE-780 SERIES<br>SD-76                    | SHADOWFORM                                    |
| RECEPTOR & FLASHING       |  A-LINE, BCE-, BTF-, & WLB- SERIES<br>SD-10 |   |
| SNAP TRIM                 |  WLB-2000 SERIES<br>SD-133                  |   |
| INTERIOR STOOLS           |  WLB-3000 SERIES<br>SD-152                  |   |

NO TEST DATA AVAILABLE  
 TREDEGAR EXTRUSIONS INC. DOES NOT MAKE ANY WARRANTY EXPRESS OR IMPLIED INCLUDING  
 NO WARRANTY OF MERCHANTABILITY OR FITNESS FOR A PARTICULAR PURPOSE AND RESERVES  
 THE RIGHT TO MAKE CHANGES  
 REPRODUCTION RIGHTS RESERVED

INDEX SHEET  
SYSTEMS  
CROSS REFERENCE

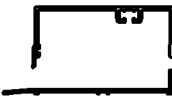

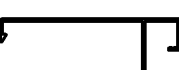

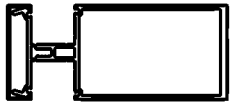
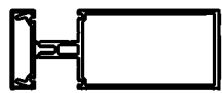
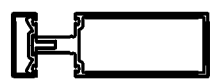



| <u>SYSTEM DESCRIPTION</u> | <u>BONNELL #</u> | <u>COMPRABLE</u> |
|---------------------------|------------------|------------------|
|---------------------------|------------------|------------------|

|   |  |                           |
|---|--|---------------------------|
| <u>1/4" or 1" GLASS</u>   | <u>PRESSURE PLATE SYSTEMS</u>  | <u>COMPETITIVE SYSTEM</u> |
| 3" FACE MULLIONS<br>3", 4 7/8", 5 1/2" MULLS<br>3", 4", 5", & 7" TUBES      |  BCE-330 SERIES<br>SD-135 |                           |
| 2 1/2" FACE MULLIONS<br>2 1/2", 3 1/2", 4 1/2",<br>5 1/2", 6 3/4", & 9 1/8" |  BCE-250 SERIES<br>SD-49  | 1600 SERIES<br>70 SERIES  |
| 2" FACE MULLIONS<br>2 1/2", 4 1/4", 4 1/2"<br>4", 5", & 6 1/2" MULLS        |  BCE-200 SERIES<br>SD-58  |                           |

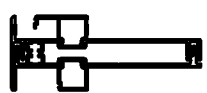
|   |   |                |
|---|---|----------------|
| <u>1/4" or 1" GLASS</u>                               | <u>SNAP COVER SYSTEM</u>  |                |
| 1 3/4" SNAP FACE MULLION<br>2 9/16" & 4 1/16" GUTTERS |  BTF-1700 SERIES<br>SD-128 | NU-CORE SYSTEM |

|  |   |  |
|--|---|--|
| <u>1/4" or 1" GLASS</u>                          | <u>2 SIDED SILICONE SYSTEM</u>  |  |
| 2" BUTT GLAZED MULLION<br>3" & 4" DEPTH MULLIONS |  BTF-700 SERIES<br>SD-66 |  |

|                               |   |                  |
|-------------------------------|---|------------------|
| <u>1/4", 5/8" or 1" GLASS</u> | <u>FINNED SYSTEMS</u>   |                  |
| 3" MULLION, TAPE GLAZED       |  BTF-300 SERIES<br>SD-31   | SEAMLESS MULLION |
| 4" MULLION, TAPE GLAZED       |  BTF-400 SERIES<br>SD-30   | SEAMLESS MULLION |
| 6" MULLION, TAPE GLAZED       |  BTF-600 SERIES<br>SD-32   | SEAMLESS MULLION |
| 4" MULLION, DRY GLAZED        |  BTF-1400 SERIES<br>SD-120 |                  |
| 3" MULLION, DRY GLAZED        |  BCE-490 SERIES<br>SD-72   |                  |
| 4" MULLION, DRY GLAZED        |  BCE-470 SERIES<br>SD-72   |                  |

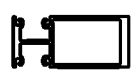
|                   |   |  |
|-------------------|---|--|
| <u>1/4" GLASS</u> | <u>CAN SYSTEM</u>   |  |
| 3 11/16" MULLION  |  BCE-2000 SERIES<br>SD-155 |  |

NO TEST DATA AVAILABLE  
 TREDEGAR EXTRUSIONS INC. DOES NOT MAKE ANY WARRANTY EXPRESS OR IMPLIED INCLUDING  
 NO WARRANTY OF MERCHANTABILITY OR FITNESS FOR A PARTICULAR PURPOSE AND RESERVES  
 THE RIGHT TO MAKE CHANGES  
 REPRODUCTION RIGHTS RESERVED